

MAX FAX



Journal of the D. C. Maxecuters

... home of the dreaded POTOMAC PURSUIT SQUADRON of the Flying Aces

Editor: Stew Meyers

2013-4 (JUL-AUG)



COMING ATTRACTIONS

We get together every Tuesday at 11:30am at Mylo's Grill for lunch.
6238 Old Dominion Dr, McLean, VA

Bauer Community center is available for indoor flying Mondays and Wednesdays
from 12:45 to 2:15 PM during the school year.
The address is 14625 Bauer Drive, Rockville, MD

The Culpeper County Air Fest Saturday October 12 2013

BARRON FIELD AIR RACES (WAWA)
Saturday, Oct 19 & Sunday, Oct 20 2013, Barron Field Waywayanda, NY.

12, 13 & 14 October 2013 — Gathering of the Turkeys Contest
AMA, NFFS, SAM and FAC Events-- Pensacola Navy Site 8A
George White, CD, 850-473-0866 or white76@cox.net

SEE WEBSITE FOR MORE CONTESTS AND DETAILS

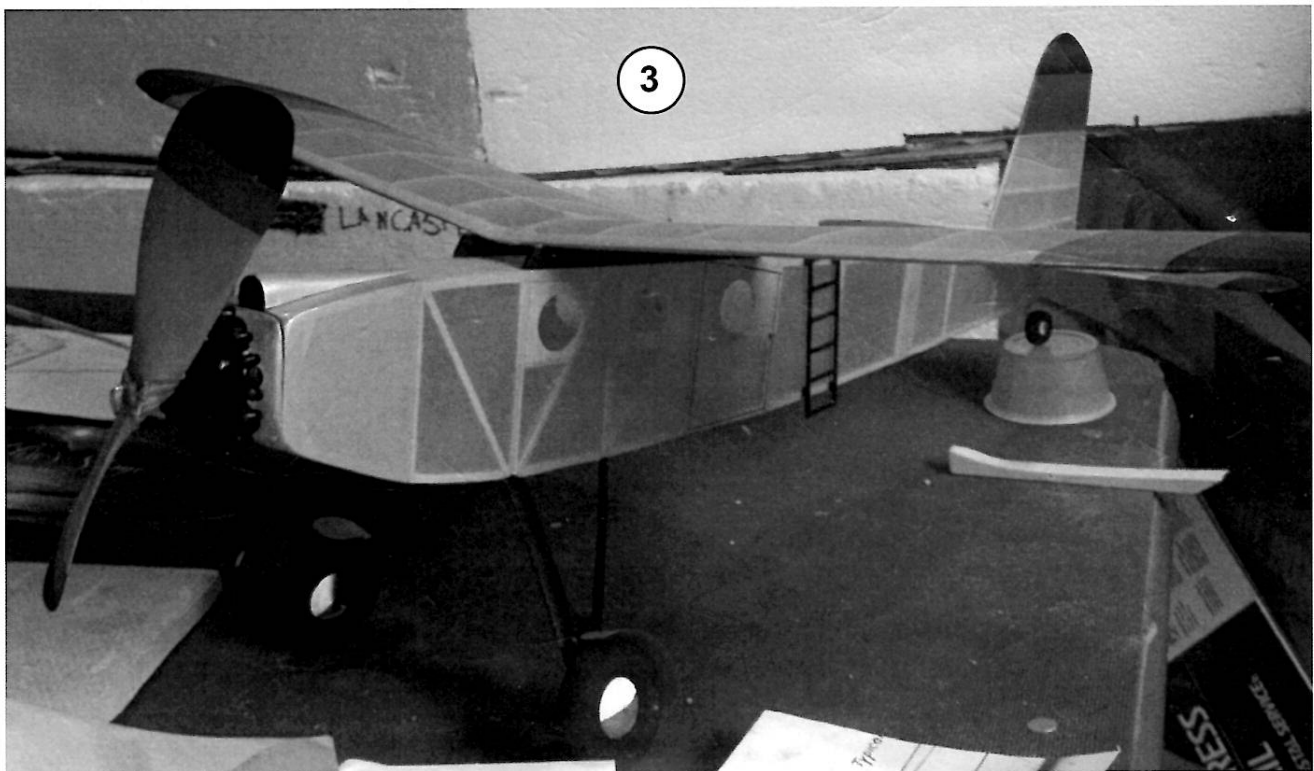
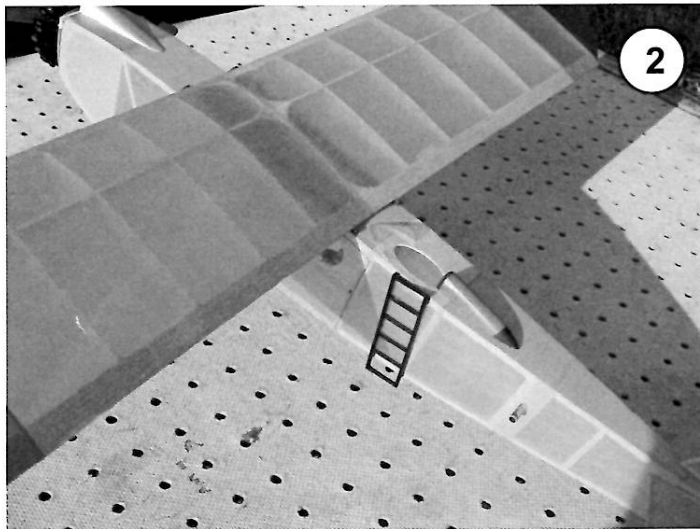
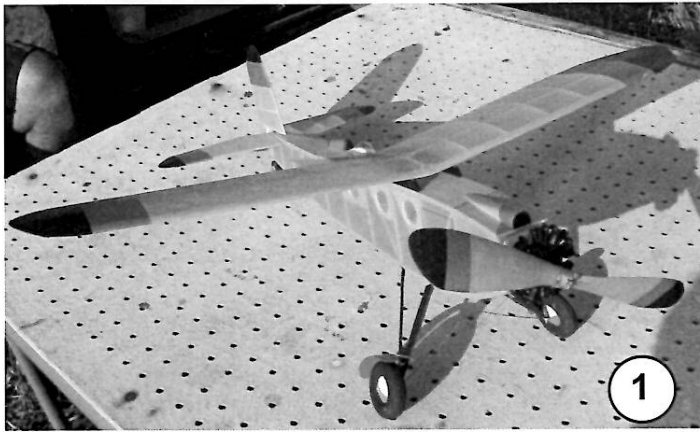

AN ARGUS SPECIALIST PUBLICATION

TOM SCHMIDT

FEBRUARY 1990 £1.95

AERO

MODELLER

HOT PURSUIT

Vintage favourite revisited

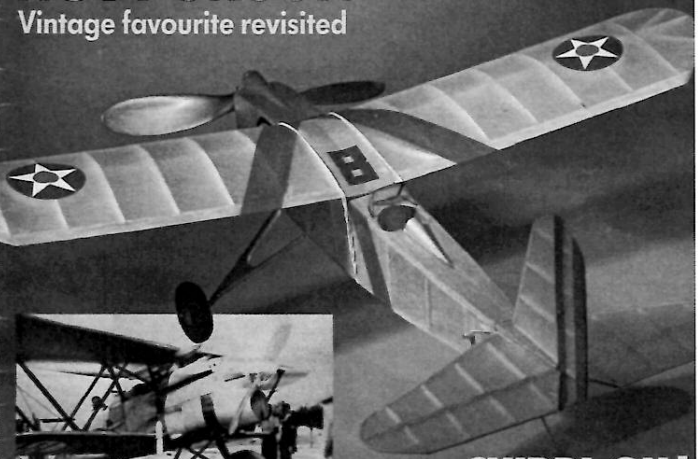

CHIRRI-OH!

Fiat CR 32 scale drawings and full-size plans

KOODAVBEEN and FP15

Build our foam fun fliers

4



3

MaxFax 2013- 4
(JULY-AUG 2013)

Stew Meyers Editor

NAVY PURSUIT ISSUE

In the 2013-2 Navy Racer Issue, I mentioned the Jan 1934 Flying Aces Navy Pursuit. The Navy Pursuit looks like a proper model airplane; if you look up the definition of model airplane in a dictionary, this model should be the illustration. The FAC News #270 had a photo of one that Vance had built. I emailed him and he sent me the plans he used and a scan of the article and some photos. At the Non-Nats I took some more photos of his model. I had the Feb 1990 Aeromodeller with Alex Imrie's feature on it in his Vintage Corner. I have to say I agree with Vance and Alex on the approach to building these old models. Dan Driscoll recalled that Alan Schanzle had published the original plans in the Nov/Dec 1992 issue of MaxFax. I guess it's ok to do it again with a more complete treatment.

I often find after putting out an issue on a model, I get so intrigued by it that I build it and find some things I wished I had mentioned in the article. So this time I held off on putting out the issue until I had built the model. I have redrawn the Navy Pursuit plans since Vance noted everything didn't quite fit, which is not unusual with these old plans. I also have included drawings of parts I needed to build it that weren't on the plans. Keith Sterner saw me fly it at Muncie and sent me the plans he redrew in 1991. These are essentially unmodified from the Flying Aces plans, except for changes necessary to actually build it. I was originally going to include the Flying Aces plans at full scale, but since I now have Keith's clean up of these, they are presented at half scale. Keith's drawing is too large for news letter format and I hated to carve it up so it is also presented at half scale. A full scale PDF of Keith's drawing is available on the Maxecuter website.

A cyanoacrylate adhesive poop sheet from Bob Smith industries has a lot of good information.

Photos Page 2

1. Vance Gilbert's Navy Pursuit in mufti.
2. Whimsical cockpit treatment on Vance's model.
3. Mud fenders, port holes and a radial engine set Vance's model off.
4. Cover of the Feb 1990 Aeromodeller showing the same color scheme as the original 1934 Flying Aces Navy Pursuit.

The cover of this issue shows Vance launching the Navy Pursuit at WaWa earlier this year.
Tom Hallman photo.

MEMBERSHIP - Dues for membership in the DC MAXECUTERS are **\$25** per year for residents of the USA, Canada, and Mexico, and **\$35** for all other countries. You may now use PayPal at the website: **www.dcmmaxecuter.org**

Your mailing label indicates the year and month of the last issue of your current membership. A red "X" in the box below is a reminder that your dues are due. Send a check, payable to the "D.C. MAXECUTERS", to the treasurer, Stew Meyers.

PUBLISHING DATES - Six issues of MaxFax are sent each year as close to the nominal dates as possible, but since this is a volunteer publication nothing is guaranteed except that six issues will be sent to all members. (*Rising costs and dwindling membership may force us to go to four issues a year some time in the future.*)

CONTACTS - Material for the newsletter and membership questions should be addressed to Stew Meyers phone 301-365-1749. Email gets immediate attention. stew.meyers@verizon.net



It saddens me to report Norm Davision succumbed to cancer on August 6th. One of the more idiosyncratic of the DC Maxecuters, Norm was the moving force behind the Bauer Center indoor flying sessions, one of the longest running and consistent Maxecuter club activities of recent years. He was deeply engaged in bringing the pleasures and challenges of model aviation to today's youth, serving for many years as a coordinator and instructor for local middle school aviation building programs. A regular attendee at the FAC Nats / Non Nats, Norm was an apparently indifferent competitor, but was a keen and assiduous collector of all things related to model aviation. Never an event went by but that Norm came home with another half-dozen precious acquisitions, which filled his home and gave him great pleasure. More than all that though, he was a great friend and true humanitarian, whose enthusiasm for life touched all who knew him. They broke the mold after they made Norm---he will be sorely missed.

VINTAGE CORNER

Motivation - and the Flying Aces

Navy Pursuit - tried and tested by

Alex Imrie

Right: Characterful cover of the January 1934 issue of Flying Aces wherein appeared the neat Navy Pursuit. WWI dogfight painted by Paul Bissell. This photo: Tissue decoration of red chevron and fuselage band, period stars and rudder stripes plus aluminium coloured nose, undercarriage and propeller give this pursuit ship a happy look.

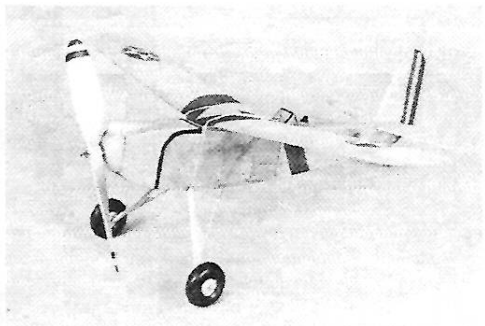
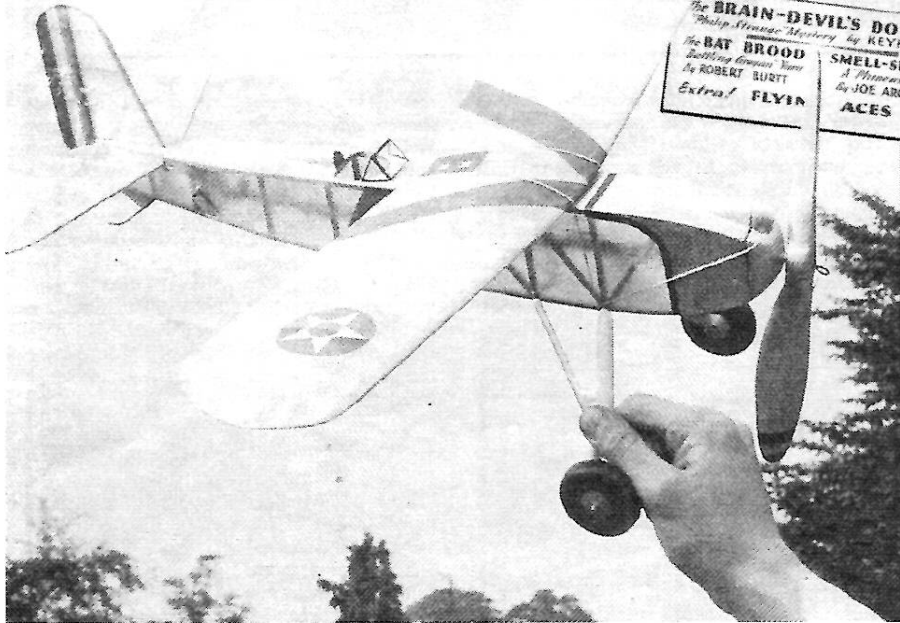

HOW do you decide on what model to make next? Do you review all available designs, study their structures; then, having made your choice, collect all the materials carefully together and work away at the construction as your spare time allows? Or do you find yourself starting to build on the spur of the moment, and as you get more involved with your project, organise your resources (which includes 'finding' the time) accordingly? Or do you merely threaten to build various models, actually putting off starting on any of them because the essential urge is not present? I personally have a list of models that I would like to build; they occupy strict priority positions, but sometimes, due to

a curious quirk of human nature, some designs appear to jump the queue like my Flying Aces Navy Pursuit... or was it always at the 'number one' position anyway? If so, why did I not build it years ago? And why did I, with a million other things to do, suddenly make time for it now? I am certainly pleased that I did because it has just given me a most pleasurable 'scrapbox' experience.

Flying Aces Navy Pursuit

In the early 1930s any aviation magazines finding their way into our household were immediately purloined and kept under my bed in a large Palethorpe Sausages cardboard box. They were regularly devoured from cover to cover and

were more-or-less memorised, much to the detriment of my school work. It was doubtless paternal correction of their erring son's ways that caused this rather tattered collection (a hazard to health it was said) to mysteriously 'disappear' one day! The January 1934 issue of Flying Aces was one of my favourites. As an eight-year old I longingly studied the plans in the model section wishing that I could build the designs shown. Time passed... some forty years in all, occupied by other aeroplanes, both full-size and model; then one day I borrowed some magazines from Ron Raddon that included that January 1934 issue and could immediately recognise many of the illustrations and the model articles that had made such an impact on me all those years before. I copied the drawings of Julius Unrath's little model on a piece of transparent paper, obviously intending to build it; but never did. More years slipped by and eventually I obtained my own copy of this magazine, but apart from reading it with interest, made no attempt to build the Navy Pursuit. The time was obviously not yet ripe. Then, only a few days ago while looking amongst my plans for something else, the pencilled drawing on greaseproof paper resurfaced - suddenly I was eight years old again and the Flying Aces magic that I had known took over.

Before I consciously realised it, the building board was out and I was reaching for the balsa cement and the 1/8in square strips and went right on to finish the model, completely ignoring all other, more important demands on my time. There was no rational explanation for this behaviour other than the sheer enjoyment of every minute taken to build that simple little model that had attached itself to me fifty-five years ago. The Flying Aces Navy Pursuit is really a 23in high wing fuselage sportster-type model, and the addition of an open cockpit, windscreen and headrest, plus a dummy engine cowling makes it more appealing than a straight duration model. The structure is not only simple, there is not much of it, and it can be built from the offcuts that one usually throws away. The bent-bamboo tips of the flying surfaces make it 'different' in this day and age, this material also being used for the trailing edges of the tail unit. The pre-war Ante wheels that I used were products of The Model Shop that had seen service on a friend's Keil Kraft Rover in 1948. The axle holes were elongated and the tyres split and broken. I re-bushed them, glued them together and repainted them and despite their half-ounce weight their profile really suits the model, so they were a worthwhile restoration. How about a propeller? I had a plastic one of the right size (scorn the thought) but used balsa and fitted a Garami simple spring-aside, latch-type freewheel. Of course, I cheated and built in some right thrust and downthrust when I drilled the noseblock for the screwed brass bush, and I used a peg rear motor anchorage instead of the motor stick, so common on American models of the time. Then there was the fun of decorating it as per the pictures of the original model, with coloured tissue stripes on the rudder, fuselage and wing, correct period US National star markings and that silver cowling and propeller marked with its red, yellow and black tips. Too soon, it seemed, the model was finished. It weighed 3.1/2 ounces with six

strands of 1/8th rubber for I had not attempted to keep it light - would it fly?

On low winds the model was surprisingly stable in the air and made some delightful low-level circuits. Various adjustments were tried but these did not seem to alter the flight pattern very much, so eventually all were removed and four strands of 1/4in rubber chosen. Now, as the number of turns were increased, she really lived up to her name. Due the coarse-pitch propeller and the built-in nose block thrust settings, the model flies away in level flight straight ahead for some thirty feet or so; then, just as if a pilot is at the controls and has pulled the stick back, the model zooms in a steep climb to orbit at over 100 feet. What a thrill for an eight year old this would have been... This takeoff manner is surprisingly like that of my Elf-powered Miss San Diego. Model aerodynamicists will be able to explain the forces at work; to me it seems that in both cases acceleration to a suitable flying speed is necessary before the models 'do their stuff'.

At the end of the first flying session, which went on until it was almost too dark to see the model, its flying was most consistent, the model achieving forty seconds on about 400 turns in the dead, damp evening air. With some lift in the air there is no telling what adventures and feats of endurance will befall this dream ship of mine! Build one and share my fun. Drawings are presented here no building instructions are necessary. If you don't wish to go as far into the past as I did, use laminated bass or balsa instead of bamboo for those outlines and fit a plastic propeller.

F.A. Navy Pursuit Material info...

Fuselage from 1/8in square balsa. All diagonals 1/16 x 1/8in balsa. All ribs from 1/16in sheet. Fuselage top covered 1/32in balsa; 1/16in balsa inserted in sides and bottom of front fuselage bay. Wing tips and tailskid 1/16in bamboo. Undercarriage: wire faired with balsa. Wheels 2in diameter. Tailskid fairing 1/16in sheet balsa. Tail unit spars 1/8in square, sanded round.

Leaving well alone

An early rubber flying scale model of the 1930s kit type (like Burd or Megows) has a special attraction all of its own. Generally, it is not a model of an aeroplane at all, but rather, it is only a model aeroplane and cannot be confused with anything else. Despite (or more correctly, because of) its inaccuracies, it is a different breed altogether from the splendid, exact-scale models that are so much a part of the present-day scene. To keep it this way does not require any embellishment, but refraining from altering it can be difficult.

It is true to say that most modellers change vintage designs slightly during construction. They 'add more lightness', fit undercarriages that 'give', usually replace the rear hooks with the more practical wooden peg or aluminium tube rear anchorages, and invariably use modern practice in their motor make-up and propeller design, often incorporating some means of freewheel. Should you pursue this avenue, don't use the above as an excuse to change too much and get carried away with modifications if you wish to retain that certain aura that only these oldies possess. Don't alter the decoration, finish and markings either; use the old ...

(continued on page 15)

Fly the Flying Aces Navy Pursuit!

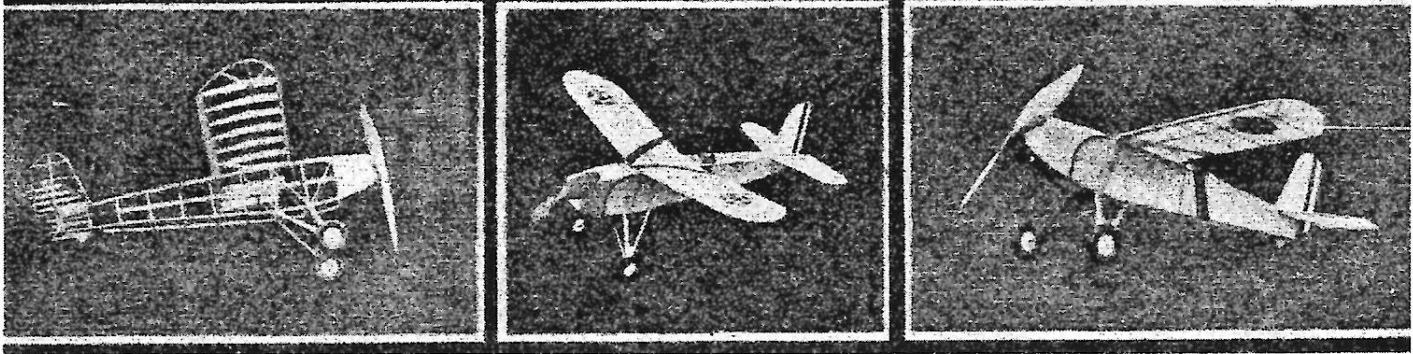

"Look at that model climb!" If you model enthusiasts want to hear those words, take a look at the plans and instructions printed here for the Flying Aces Navy Pursuit, build the ship—and then watch it fly! It's a real pursuit plane, and takes off in from six to eight inches, by actual test.

By Julius Unrath

LOOK at that climb!" When you fly the model presented here, you'll often hear those words from both model enthusiasts and ordinary spectators. For this really is a "pursuit" plane in its flying ability, because the take-off distance is approximately six to eight inches. This has been tested and proved at Van Cortlandt Park, New York City, where twelve parallel lines were made, one inch apart, in fine sand, and the model was started on the first line.

The wheel marks showed that the model always left the ground in between six and eight inches. This performance is due, not to excess rubber, but to the airfoil and propeller. During construction, remember to use extreme care and the Flying Aces Navy Pursuit will prove itself a real gem in your collection.

FUSELAGE

START by placing the longerons $\frac{1}{8}$ " sq., over the full-size drawing with pins or weights. The compression members (braces) should then be cemented in place. When this is done, the two sides should be assembled by cementing the top and bottom members in place.

Next, cover the top of the fuselage with $\frac{1}{32}$ " flat sheet balsa and cut out the cockpit. The nose should now be cut, drilled and securely cemented to the fuselage.

The landing gear is the next problem. This is made of wire, faired with balsa. The struts should be bent and fastened to the fuselage. Before the fairing is attached, a drop of solder should be placed where the two struts meet.

The fairing is made from $\frac{1}{16}$ " flat balsa, fitted and cemented to obtain the correct shape, then sanded to a streamline shape.

The headrest and windshield are next made and cemented in place. When making the tailskid, bend a piece of $\frac{1}{16}$ " sq. bamboo to fit and use $\frac{1}{16}$ " flat balsa for fairing. The motor stick is made and fitted so that it will fit securely into the fuselage. The fuse-

lage is now covered with three pieces of tissue, one for each side and one for the bottom.

TAIL ASSEMBLY

THIS is quite simple. The ribs should be cut and cemented to the spars; then the leading and trailing edges are cemented in place and shaped. Always remember to keep them true so that the model will act as it should. The rudder and stabilizer should both be covered with two separate pieces of tissue, then trimmed and cemented to the fuselage. The fuselage and tail surfaces should now be sprayed with water to tighten the covering.

WING AND PROPELLER

THIS surface is made in the same manner as the tail surfaces. Extreme care should be used, however, to insure every rib's being alike, and to prevent any warping in the wing when assembled. The wing should be covered with six pieces of tissue, two for each half and one for the upper surface of each wing tip. Like the fuselage, the wing should be sprayed with water.

For the propeller, a block of hard balsa is cut to the shape shown in the drawing and carved so that it turns clockwise when faced from the rear. When this is finished, the corners should be rounded, the prop balanced and the shaft inserted and cemented.

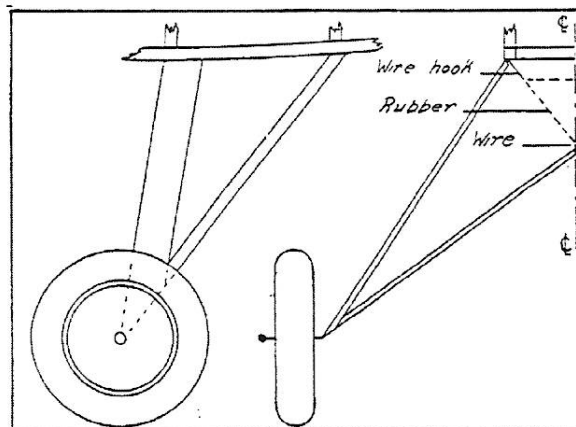

Half-scale drawing of the landing gear of the Flying Aces Navy Pursuit.

ASSEMBLING, DOPING AND DECORATING

THE entire model should receive two coats of dope composed of 60% acetone and 40% banana oil. Red, white and blue stripes are cemented to the rudder. A red stripe is cemented on each side of the fuselage near the cockpit. The wing has a red "V" (in which a numeral can be cemented) and two U. S. stars on each half (top and bottom). The landing gear, headrest, propeller and nose are painted silver with black detail. See diagram for detail of landing gear.

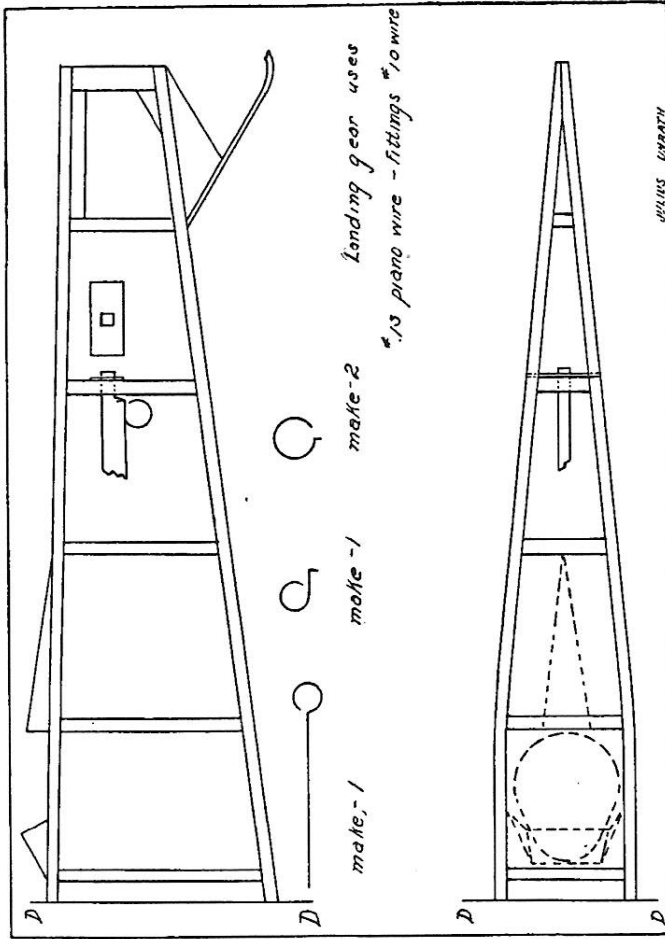

WILLIS DUNNATH

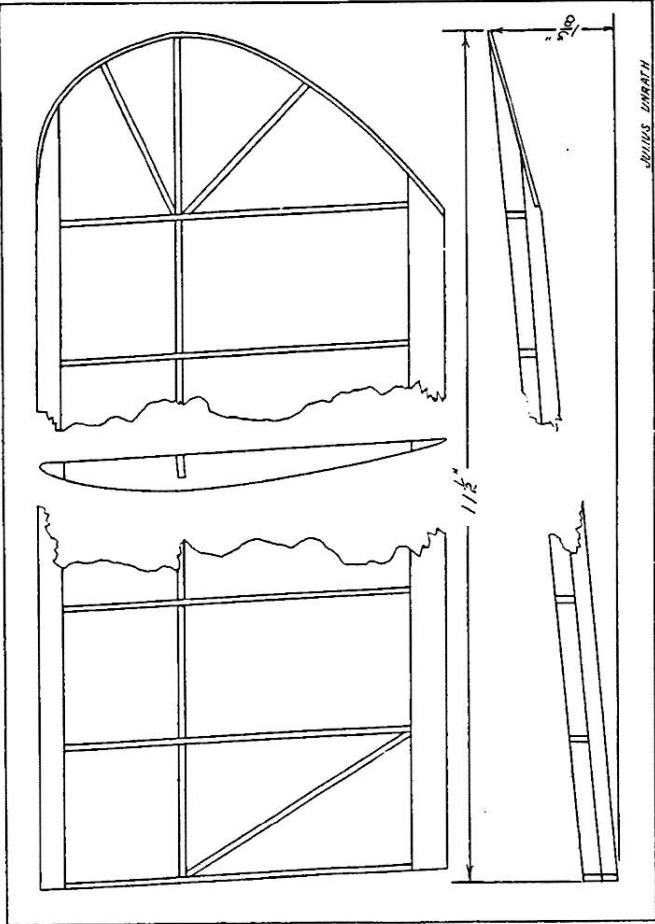

WILLIS DUNNATH

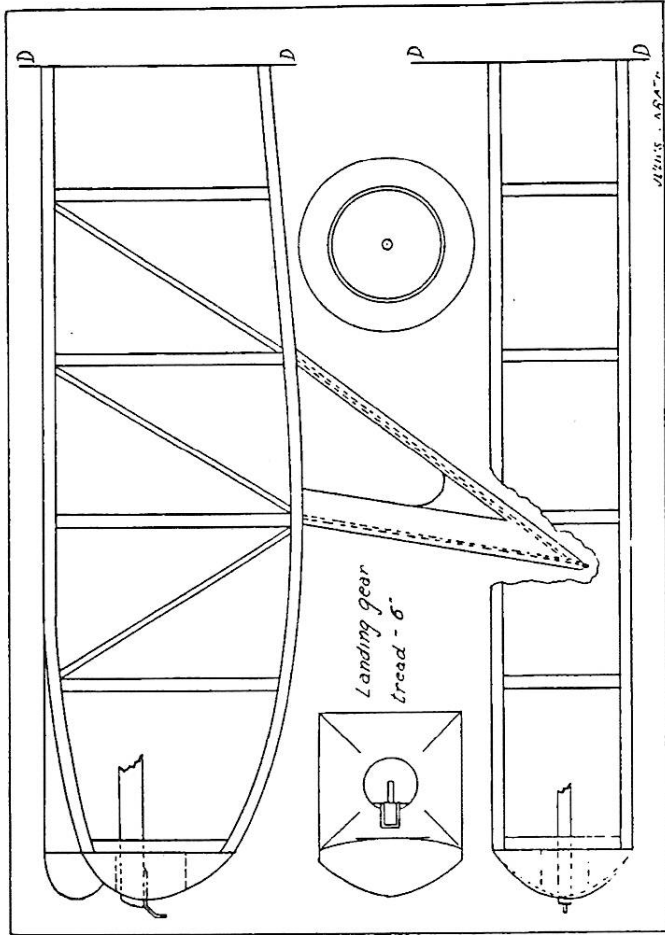

WILLIS DUNNATH

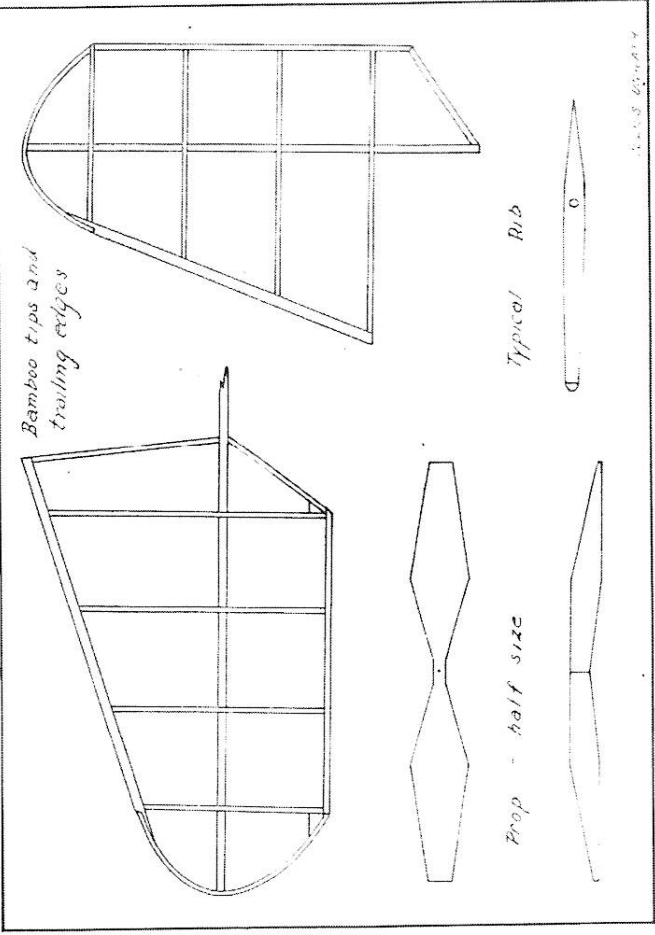

WILLIS DUNNATH

1933 FLYING ACES "NAVY PURSUIT"

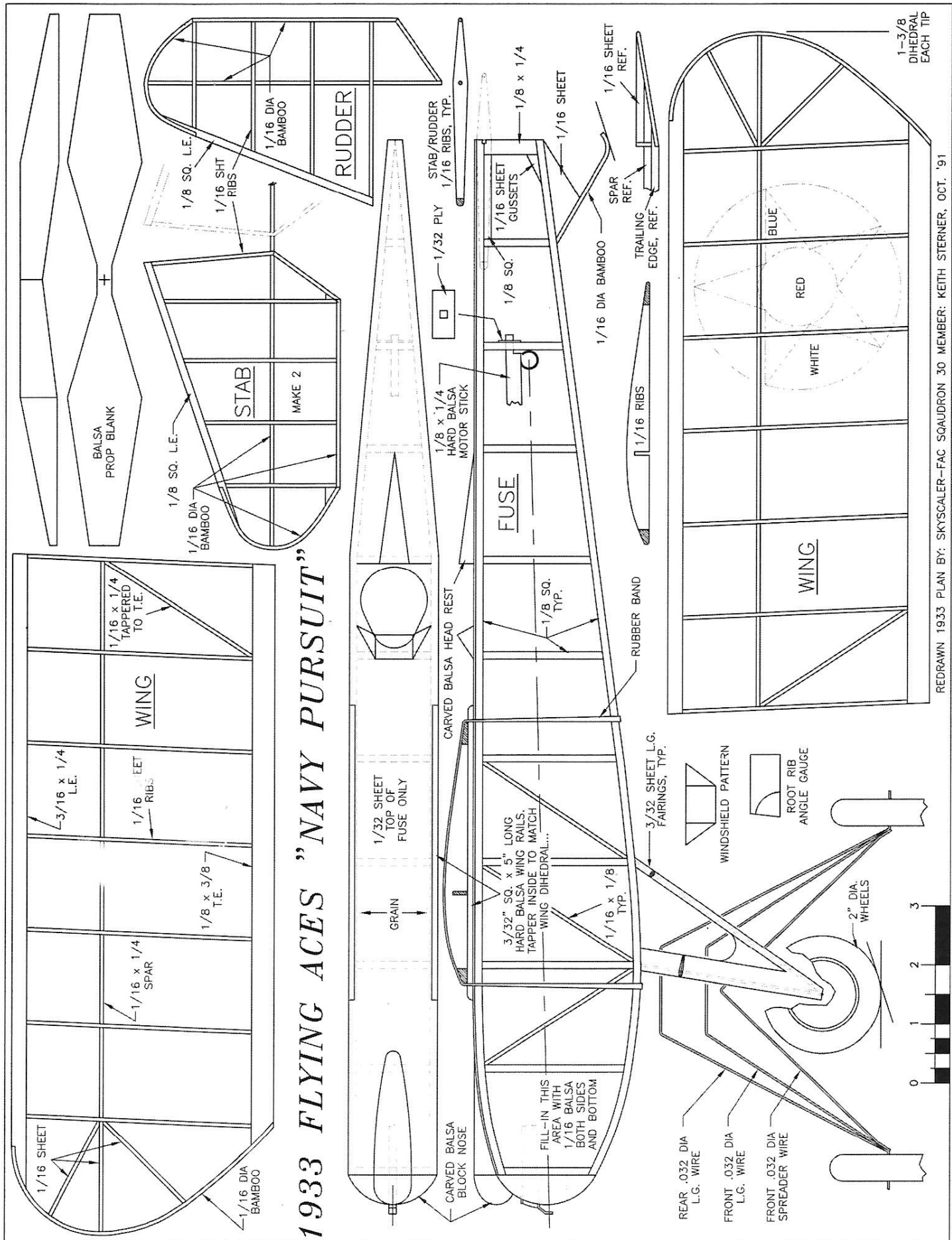

USING CYANOACRYLATE ADHESIVES

Cyanoacrylates (CAs) have become the adhesive of choice for most hobby and household applications. High quality CAs such as INSTA-CURE™, when used properly, form bonds that in many cases are stronger than the material that is being adhered. INSTA-CURE™ is a highly refined CA which, combined with its freshness, gives a guaranteed 2 year shelf life.

CAs are reactive monomers that chemically link (polymerize) when pressed into a thin-film. The very thin layer of water moisture present on most surfaces acts as an alkali, or weak base, which is the catalyst that results in bonding; however, the presence of detectable amounts of water usually degrades the performance of CAs.

INSTA-CURE™ has a water-thin viscosity that wicks deep into joints by capillary action and cures in a matter of a few seconds. Surfaces to be bonded must be tight fitting and should be held together while you apply the CA around the edges of the seam. At the moment CAs cure, they give off a vapor that can irritate the nose and eyes, so be prepared. Thin CAs work very well on balsa since they penetrate into the wood and form more than just a surface bond.

INSTA-CURE+™ is a higher viscosity CA for loose fitting joints in which the - adhesive must bridge gaps. Normally, the thicker CA is applied to one surface and then the parts are held tightly together for about 5 to 15 seconds. For large surface areas, including those with close fitting joints such as laminations, INSTA-CURE+™ should also be used. To prevent premature curing, don't spread the glue into a thin film. Lay down a serpentine bead with about 1" separations on one surface, then assemble the parts, letting the pressure spread the CA out.

INSTA-SET™ is a catalyst which acts as an accelerator that allows CAs to quickly cure in thick layers by enhancing the alkaline conditions during polymerization. INSTA-SET™ in a spray bottle is normally used to cure the CA that flows from joints when parts are pressed together. Applying an additional bead of thick CA along a seam and then curing it with INSTA-SET™ significantly enhances a joint's strength. For difficult to bond materials, INSTA-SET™ can be applied to one surface and CA to the opposite surface. When brought together, they will bond instantly. INSTA-SET™ is formulated with a strawberry scent and activates CA in 6 to 8 seconds with little degrading of the CAs strength, which is a problem with many other accelerators. INSTA-SET™ is 100% foam safe and can be used on clear plastic.

MAXICURE™ extra thick 10-25 second CA is the best CA for most plastics, including GE's Lexan™. MAXICURE™ is the best choice for plastic model assembly. When used with INSTA-SET™ it will fill most voids. It can be carved with a knife or razor blade and sanded to form a finish indistinguishable from plastic. Its extra thickness makes MAXICURE™ easier to work with for most applications. MAXICURE™ bonds hardwood and plywood better than any other hobby adhesive. For gluing to the inside, cloth textured surface of fiberglass, scrape the area to be bonded with a razor blade or coarse sandpaper before using MAXICURE™ or any other adhesive. Plywood should be lightly sanded before bonding.

SUPER-GOLD™ and SUPER-GOLD+™ are our odorless INSTA-CURE™ CAs. They are non-frosting and take only 2 or 3 seconds longer to bond. There are no fumes that irritate the nose and eyes. The SUPER-GOLD™s are 100% foam safe; therefore, they can be used in the building of foam core wings and the assembly and repair of plastic and foam ARF's. They will not fog clear plastic. SUPERGOLD+™ is ideal for attaching clear canopies in plastic model kits; however, MAXICURE™ is still recommended for assembling the rest of plastic kits. Wood can be bonded to white foam with SUPER-GOLD+™ in less than fifteen seconds. For bonding foam to foam, spray a very light fog of INSTA-SET™ to one piece and apply SUPER-GOLD+™ to the other before joining. Excess INSTA-SET™ may create too much heat, which can melt the foam. Both SUPER-GOLD™s cure to a more flexible consistency for better shock absorption. Whenever a large amount of CA is to be used in such applications as saturating fiberglass or Kevlar, SUPERGOLD™ eliminates the irritating fumes from the evaporating monomer that make repeated use of CA unpleasant at times.

IC_2000™ is a rubber-toughened cyanoacrylate that forms superior shock resistant bonds on non-porous surfaces. The black colored CA has added flexibility for the bonding of metals, fiberglass, rubber, carbon-fiber and other advanced materials. For model use, IC2000™ is ideal for the bonding of bulkheads, formers and servo rails to the inside of fiberglass hulls and fuselages. Set-up time is 20-40 seconds, which can be accelerated with INSTA-SET™. When cured, IC2000™ is pliable enough to be carved with a hobby knife. IC2000™ is the best adhesive for R/C car tires.

UNCURE™ debonder will soften cured CA. If parts are bonded incorrectly or your fingers are stuck together, a few drops of UNCURE™ will dissolve the CA in about a minute. Apply on bonded skin and roll apart fingers. Once unstuck, use acetone to clean off softened CA, then wash off with soap and water. UNCURE™ will easily remove the adhesive residue from price tags or tape, but care must be taken since it will also remove the paint from many surfaces; however, this also means it is an extremely good solvent to clean paint brushes.

HINTS AND TIPS

IC-GEL™ is a cyanoacrylate paste that is extremely thick which comes in an applicator tube like toothpaste. It has the same bonding and curing time characteristics as MAXI-CURE™; IC-Gel™, however, can be applied to a vertical surface and will stay in place. It will not run. This can be very convenient for some assembly applications. Applying CA to the bottom of a horizontal surface, such as a ceiling, can be very difficult with anything other than a full standard CA bottle. IC-GEL™ can be applied at any angle with just a squeeze of the tube. The gel does, however, have a tendency to continue to come out of the tube for about a second after pressure is released, so this must be taken into account to apply the exact amount of IC-GEL™ that you want.

IC-GEL™ is an excellent putty for plastic models. It will fill any void and can be formed to many shapes. Applying INSTA-SET™ allows IC-GEL™ to be sanded or filed to final shape in less than 20 seconds. Autobody repairmen have finished their jobs in a fraction of the time by using IC-GEL™ with the additional advantage over normal body putties of superior bonding to metal surfaces. IC-GEL™, along with MAXI-CURE™, is also used for the underwater bonding of coral frags to rock.

INSTA-FLEX™ flexible thin CA is ideal for many applications, including the installation of CA hinges. When cured, INSTA-FLEX™ does not turn brittle and remains clear, even if accelerated with INSTA-SET™. It has superior shock resistance. Although not as thin in consistency as INSTA-CURE™, INSTA-FLEX™ still has good penetrating qualities and its application can be easier to control. For CA hinges, we recommend drilling a 1/16" hole in the center of the hinge slots to insure the complete saturation of the hinge when INSTA-FLEX™ is applied. INSTA-FLEX™ has a different, less irritating odor compared to regular CAs, but still can not be used on white foam. INSTA-FLEX™ has also proven to be superior when bonding anodized aluminum.

INSTA-FLEX+™ clear rubber toughened has similar qualities to our black IC2000™ but can be used in applications where you do not want the adhesive to be seen. The carbon component of IC2000™ that gives the CA its black color also contributes to its unsurpassed strength. Since INSTA-FLEX+™ has this carbon removed, its strength is a little less than IC2000™ but still superior to standard CAs. When esthetics are important and a flexible bond is required, INSTA-FLEX+™ is your best choice. It forms superior bonds to soft urethane and vinyl plastics. Both INSTA-FLEX™ and INSTA-FLEX+™ work well when bonding R/C car tires. When a joint has a larger than normal gap, flexible CAs provide superior shock resistant bonds.

MANY STORE BRAND CA'S ARE MADE BY BSI.
CHECK TO SEE IF THE *NAME™ IS THE SAME

Heat and moisture will decrease the shelf life of CAs. Unopened bottles can be stored in a freezer or refrigerator, but allow them to reach room temperature before using. Keep your bottles in a cool place that won't be exposed to direct sunlight and store away from bottles of accelerators. Due to the freshness of our CAs, their shelf life is guaranteed for 24 months.

For the initial opening of the top, loosen and retighten the top first to relieve internal pressure, then hold the bottle against a near vertical surface and cut off the top 1/32" with a knife or razor blade without squeezing the bottle. To prevent clogging, do not let the tip of the nozzle touch a surface that has been sprayed with INSTA-SET™. Before replacing the colored cap, set the bottle down hard to knock the remaining CA back into the bottle before squeezing it in an upright position to blow air through the nozzle, then wipe the tip clean.

With all CAs, the closer the parts fit together, the stronger the bond. Always hold the bonding surfaces together as tightly as possible. Any rough spots on the mating surfaces should be smoothed out. Although CAs will hold objects together with considerable strength within seconds, the full strength of the bond is not reached for several hours. Allow for this before subjecting parts to maximum stress. Also, CAs are generally a little less brittle and have higher strength when they are allowed to cure on their own.

- INSTA-CURE™ works very well with 3/4 oz. to 6 oz. fiberglass cloth for reinforcing joints. Lay the cloth on the surface and apply drops of the thin CA until capillary action saturates the fiberglass.
- Saturate the end of rope or string with thin CA to prevent it from becoming frayed.
- Cured CA is actually acrylic plastic. Thick CA with an accelerator can be used to quickly build up layers to replace or modify plastic parts. Unfortunately, neither CA or epoxy works well on most polyethylene or polypropylene, i.e., the flexible, waxy plastics.
- Small bits and shavings of plastics can be mixed with INSTA-CURE+™ to repair nicks and other damage to large plastic parts. Once cured, it can be sanded smooth to create a surface indistinguishable from the main part. This technique is used for the repair of vinyl automotive bumpers and allows the recycling of existing parts.
- R/C car tires that have been bonded to wheels using INSTA-CURE™ can be removed by putting them into boiling water.
- For the application of very small amounts of INSTA-SET™ accelerator, use our fine tip CA applicator for dispensing one drop at a time.
- Loosen and retighten the top to the CA bottle before cutting off the tip. This relieves any internal pressure from inside the bottle, which prevents CA from being forced out unintentionally.

Alex Imrie continued from page 5.....

(even though incorrect) colour schemes and insignia and you will have something special that present day designs do not have. One often hears of modellers who 'improve' old plans, and having built from them, really believe they are dealing with vintage designs. Many so-called vintage enthusiasts will not even tackle such models. An example of this thinking was brought to my attention at the sale of old plans from Vic Dubery's estate after the recent SAM 35 AGM. I watched some modellers looking through early plans which they did not purchase because they were too 'far out', these fellows obviously have still to discover the magic of true Vintage.

Mind you, many old models hardly fit into what we call flying scale. Their outlines are so poor that modellers who desire to make a scale model cannot be blamed for not selecting them, so it needs a particular dedication to complete them with the sort of abandon that I speak of.

One great difference between then and now concerns the builder himself. We are no longer boys learning the art. Usually we have considerable experience in model building, have been well educated on the subject via books and magazine articles showing us the best way to tackle various jobs and we benefit greatly as a result of seeing other modellers' work. A far cry from the lone-hand youngster of the 1930s who could only follow sometimes scant instructions, hampered by the limited materials of his mail order kit. It is a wonder that so many persisted with the hobby, but with the passage of time, their wings became less warped and their tissue less wrinkled. Nevertheless, they were usually so lacking in the know-how to make their model fly on its single loop of dry 1/8th rubber and roughly-fashioned, saw-cut propeller, that flights were seldom encouraging. However, today, the models on which some of us cut our teeth are flying strongly and well with just a little knowledge garnered over the past fifty years; but don't overdo it. Allow these old stagers to retain the dignity that is truly theirs and remember if the flying scale efforts of our forebears look out of date - that's vintage - modernise them and it no longer is!

Notes on building the Navy Pursuit.

Stew Meyers

When you build a model from old plans, you always run into a bunch of questions on how it should go together. Parts don't match from one drawing to another, Redrawing the plans brings out the problems early so they can be solved before you start building. This is of course much better than finding the problem after you have cut the parts or glued them into the assembly.

Even something as simple as the tail feathers poses questions. The LE appears to be 1/8 square, the spar 3/32 square, the TE 1/16 dia bamboo, and the tips steamed bamboo. The rib cross section shown is obviously only a schematic suggestion. Redrafting this forces one to rethink the construction. You could punch out a 3/32 hole through the rib and assemble it and the bamboo TE and tip. If so you really need to add the

gussets to the fin that are shown on the stab to secure the tip bows. You can soak a bamboo skewer in water and steam them to shape over a hot soldering iron. You then need to use a solvent based adhesive like Ambroid to glue it in place. Thick cyano is also appropriate for this joint.

The FAC allows laminating tips to replace bamboo on old designs. This is the route I am taking since I can't find my big soldering iron. I redrew the tail feathers for laminated tips. I believe the tail feathers are best built by the Earl Stahl method. I went ahead and built the fin as proof of concept for this method. The basic frame is 1/16" thick. Since the profile on the tail rib shown had a maximum thickness of 1/4" at the spar, 3/32" filler strips were added to each side bringing the total thickness to $1/16 + 3/32 + 3/32 = 1/4$. These were then shaped to provide a nice streamlined contour. Ambroid was used as the adhesive. The tip laminated from two layers of 1/16 x 1/32 basswood strips closely mimic the 1/16 dia bamboo of the original. While admiring my handy work I noticed that 1/4" max thickness looked larger than distance between the elevators on the stab and for that matter the tail post on the fuselage which measured to be 5/32". What's going on here? The fuzzy photos from the original article don't offer a clue. It's not real clear from the photos I took of Vances plane either. But from the Aeromodeller cover shot it appears the longerons come together at the back with out a bevel which would lead to a 1/4" tail post. Since only half the stab is shown, it's no biggie to open up the distance between the elevators. I'm glad I built that fin first. I am now busy redrawing the fuselage and stab.

Wing construction appeared to be straight forward. Just make sure you install the tips at an angle. It's easy to establish this angle by expending the spar past the tip and let it rest on top. After assembly add a piece of 1/16 x 1/8 from the tip rib to the tip, then trim the spar from the tip rib to the tip on the bottom. This makes the covering much easier by reducing compound curves at the tip. Make sure to set the root rib at the correct angle 5 degrees for the dihedral. Use gussets to reinforce the central joint.

Well since the rib profile looked so clean I made 16 ribs from the existing drawing. It looked like the LE was 3/16 x 1/4 and the TE 1/8 x 3/8. The spar appears to be 1/4 x 1/16. I redrew the wing by simply copying the existing drawing and extending it inboard the 11-1/2" shown on the plan. The ribs spacing didn't come out right, so I add a rib 3/4" from the root to even things up with 1-1/2" rib spacing elsewhere. When I went to assemble the wings, the ribs were a bit long. I made a procrustean adjustment, and decided to accurately redraft the wing for this issue. Thick lines from old plans don't lead to precision construction. I used TiteBond for assembly, although Ambroid would have done as well or better to bridge the gap the 2 degree sweep back produces. Don't even think about using cyano. While I laminated the wing tips from 4 layers of 1/20 x 3/32 balsa, 3 layers of 1/32 x 3/32 basswood would have been a closer representation of the original bamboo.

The method of mounting the stab is not well defined by the plans or text. They infer the spar is built in one piece connecting the two halves. The necessary notch to accommodate this is not shown on the plans, and what

do you do at the LE? Alex Imrie uses a music wire joiner that goes over the fuselage. Vance Gilbert made the center of the spar bamboo and glued it in a notch at the back of the fuselage. He then just glued the LE to the fuselage side with Ambroid.

I have elected to join the LE with a balsa joiner to make a fully one piece stab. A 1/4" slot at the rear of the fuselage lets you slide the stab in place. If you glue the fin and stab to the top of the fuselage only and hinge this you can create a pop up stab DT.

There is no mention of rails to mount the wing. But the top of the fuselage is flat and covered with 1/32 sheet and the wing has a "Vee" dihedral. You need something to elevate the edges. I made these with a two degree angle to provide a bit of wing incidence. After flight tests, I reduced this to about one degree with a 1/16 thick shim which resulted in nice glide.

A 9" prop is shown on the plans. I used a 9" Peck prop and thrust button with a 0.047 prop shaft and tube in tube clutch. Four loops of 3/16 (0.750 cross section) was not really enough power for this heavy 60 gram airframe. Eight loops of 1/8 (1.00 cross section) 30 inches long and well braided is a bit too much, but results in a terrific climb. A Crocket hook is required to corral the eight strands for winding and transfer to the "S" hook. The rear end of the rubber is on a red plastic wobbly peg. This comes from the outer sheaf of a Sig Golden Rod R/C push-rod. It's rather a tight fit. I note Vance moved the rear peg up one bay to provide more room.

On the initial test flights, the fin had a slight bias to the right. which resulted in a climbing turn to the right and a rather tight right spiral in the glide when the effects of the free wheeling prop kicked in.. A 1/16" sq. Gurney flap on the left side of the rudder corrected this and produced a good glide. Right thrust was required for a right climb and down thrust was need to tame the climb with 80% winds.

After the initial flight test, I added the details and a DT. Again the windscreen wasn't consistent from top to side view. I liked the larger versions that Alex Imrie used and have drawn these up. The head rest is a paper cone wrapped around a balsa form. The bond paper had been previously sprayed with aluminum dope. I replaced the heavy 9 gram Guillow's WWI wheels I used for the test flights with balsa wheels and a bit of ballast in the nose.

The Peck thrust button worked a little loose during the test flights and became wobbly. I stiffened the nose block with thin cyano. The 0.047 mw prop shaft is a bit wimpy for one inch cross section rubber. To make thrust adjustments easier, I replaced the Peck thrust button with a Gizmo Geezer thrust button that has a 0.055 prop shaft that is more appropriate for the motor required. While it would fit in the nose block, using a full gizmo Gizmo Geezer clutch mechanism was just too modern for me to use on this model. Besides, I plan to carve a proper prop for this model. To this end I soldered a swing clutch to the shaft.

Adding the dummy engine to the model again presented a bit of a problem. I finally decided to notch the nose block and glue the dummy engine to the fuselage top. This not only obviated the problem of trying to match the

NOTES ON KEITH STERNER'S DRAWING

If I had Keith's drawing before I built it, I probably would not have redrawn it. Keith's drawing mimics the Julius Unrath's plan as closely as possible with a few changes that are necessary to make it go together. The rear fuselage now has a 1/4" tail post that will match the fin. Wing mounting rails are shown to mount the "VEE" dihedral on the flat fuselage top.

**GET A FULL SIZE PLAN FROM
WWW.DCMAXECUTER.ORG**

part on the fuselage to that rounded extension on the nose block, but makes installing the nose block inverted impossible. Idiot proofing never hurts on my models.

Flight experience suggests the undercarriage wire should be upped to 0.047. Installing the DT changed the longitudinal trim slightly and I replaced the right bias on the fin with left. This of course necessitated further trimming, and the 0.032 rear legs buckled on some hard landings during trimming.

You can see from the photos I located the wing further aft than Keith shows on his plan. No location is shown on the original drawings. I added gussets to support dowels for wing hold down rubber bands. I hate to squeeze longerons with hold down bands, although these longerons are plenty stout enough.

While the Navy Pursuit is eligible for FAC TOTF (total of three flight) Event 11, Old Time Rubber Fuselage & Event 12, 2-Bit+1 O.T.R. Fuselage, at 60 grams airframe weight and 97 sqin wing area, it's not a floater. You build this blast from the past because it grabs you, not because you are a Kanone collector.

It spoke to me and I was rewarded with a model that's a joy to fly with zoom climb of about a minute duration from ROG at 75% turns in calm air. Hung could claim it with hefty thermal, so I added a pop up tail DT.

To make the DT, glue the stab to the top of the slot. Fillers are glued in to fill any gaps in the slot between the top of the stab to the longeron above it. The top of the fuselage is then sawed off and an R/C type hinge is used to attach the rear end and stab to the main fuselage. I used a Sig hinge. The fin is glued only to the top of the rear fuselage allowing the tail unit to pivot up in the normal DT manner. A viscus timer is placed under the fuselage just ahead of the landing gear. A capstan is used to reduce the force coming form the #12 pop up rubber band. Of course you could easily use a fuse that would be more in keeping with the era.

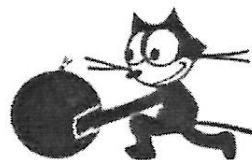

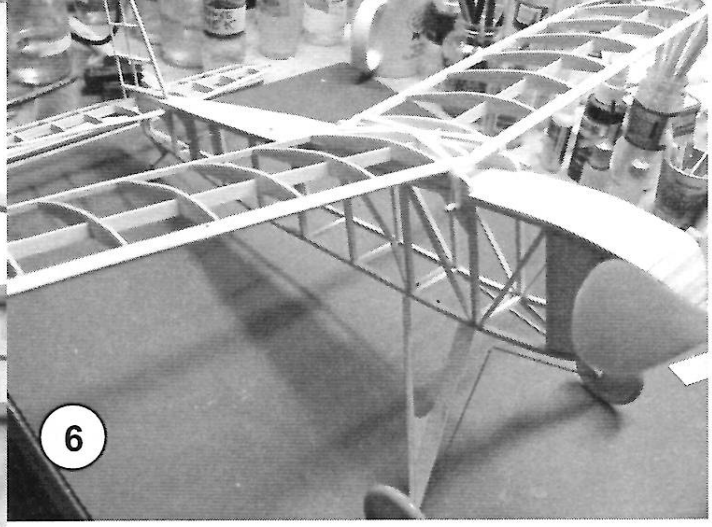
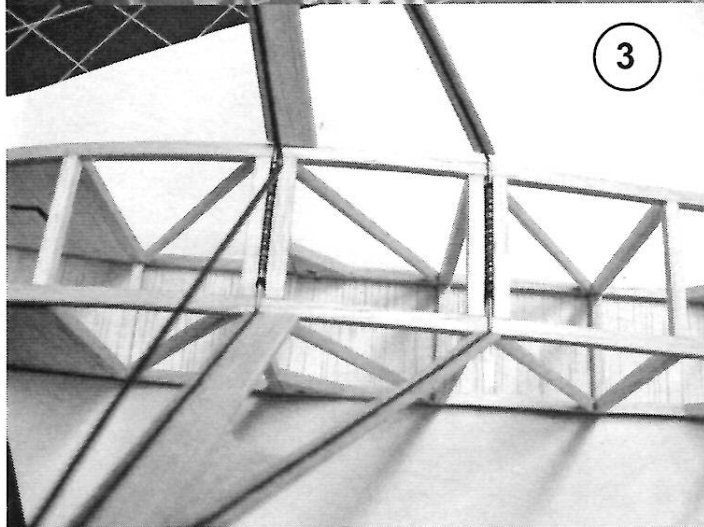
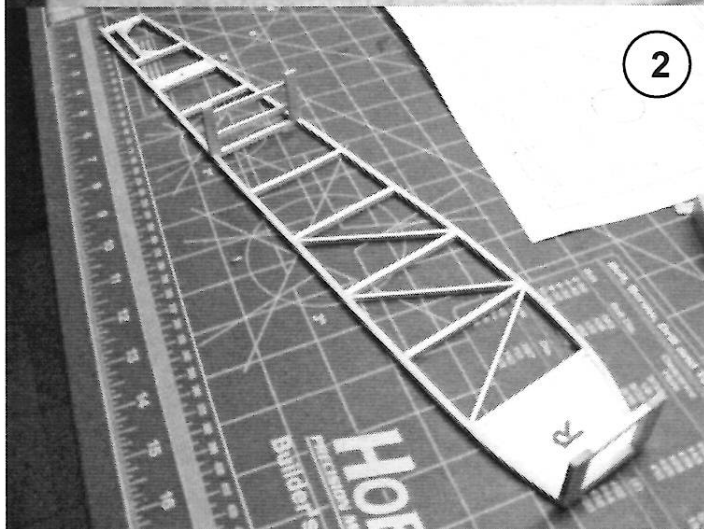
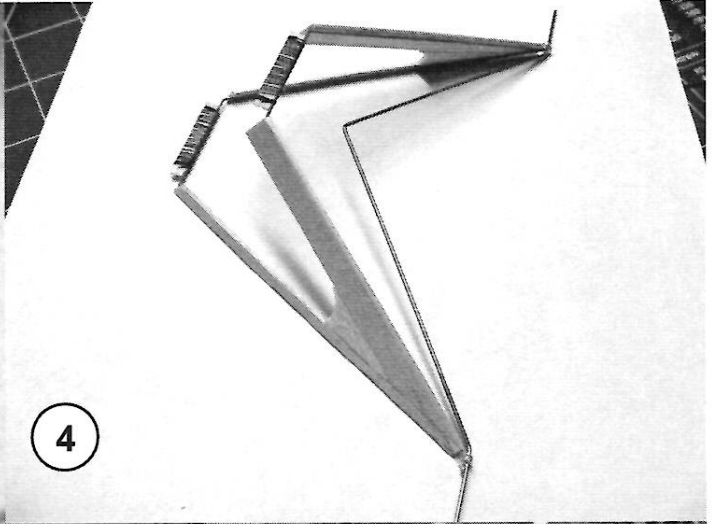
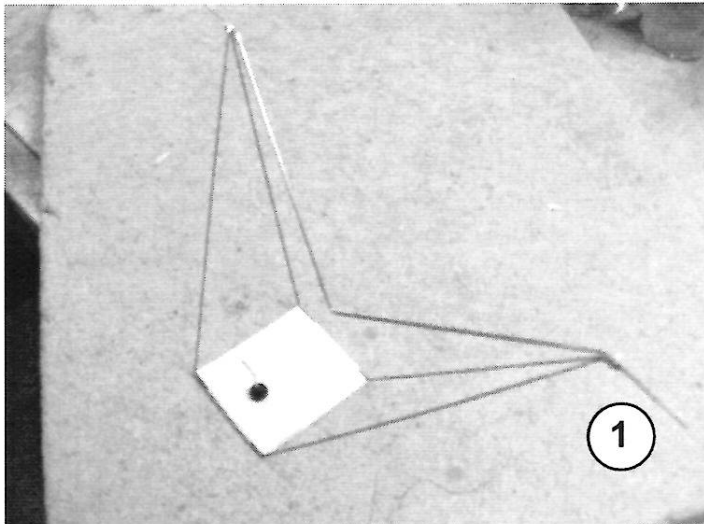

1. JIG USED TO SOLDER LANDING GEAR.
2. NOSE FORMER AND LINEUP FORMER GLUED TO SIDE.
3. LANDING GEAR TABS INSERTED INTO SLOTS IN THE FUSELAGE.
4. FAIRINGS AND MOUNTING TABS ADDED TO LANDING GEAR.
5. FUSELAGE SIDES GLUED TOGETHER.
6. NAVY PURSUIT ASSEMBLED FOR FIT TEST AND ADMIRING THE BONES.

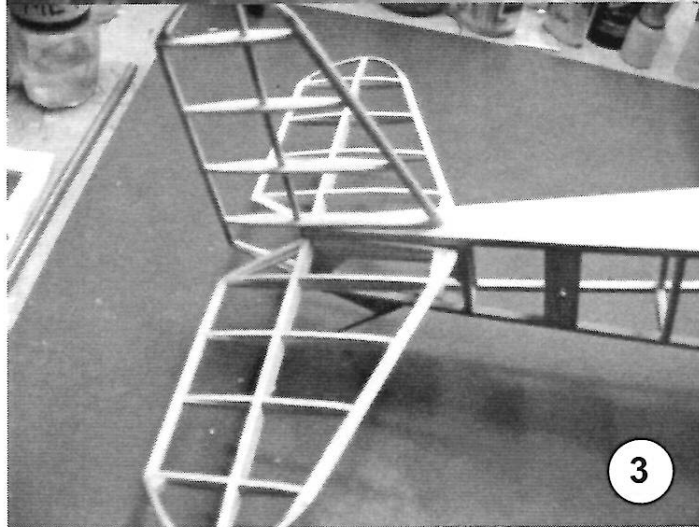
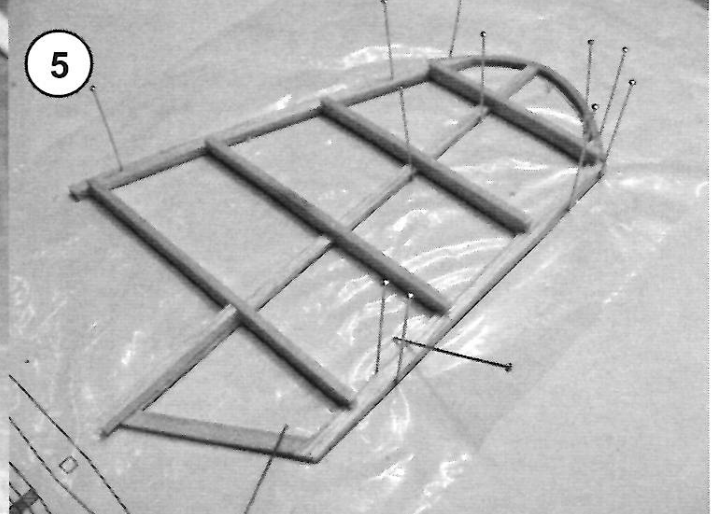
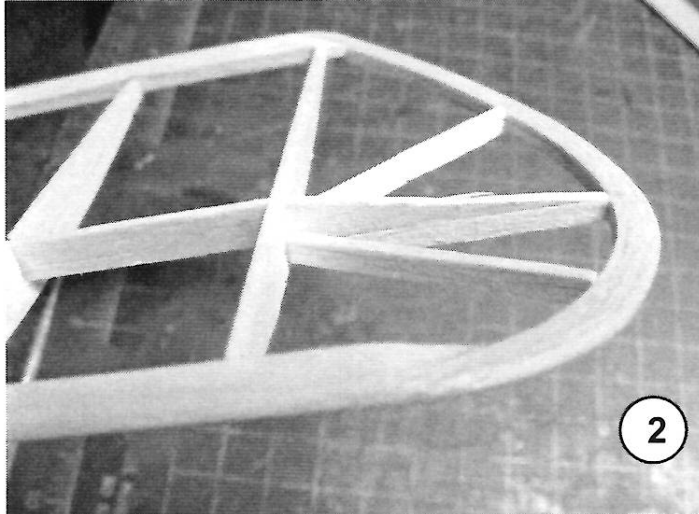
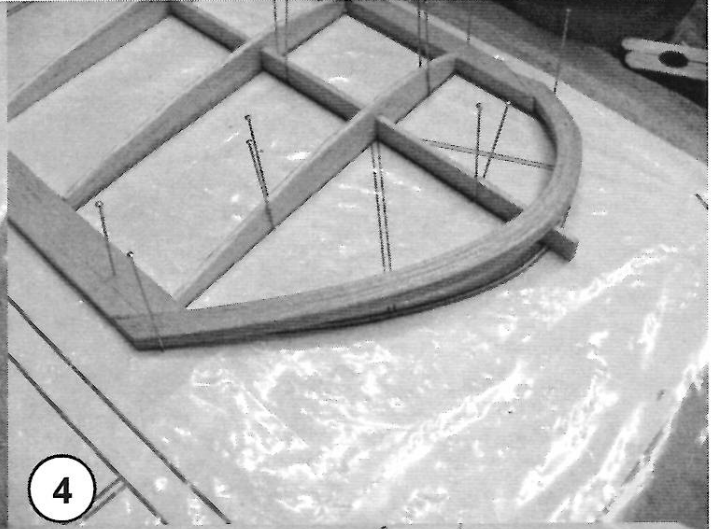
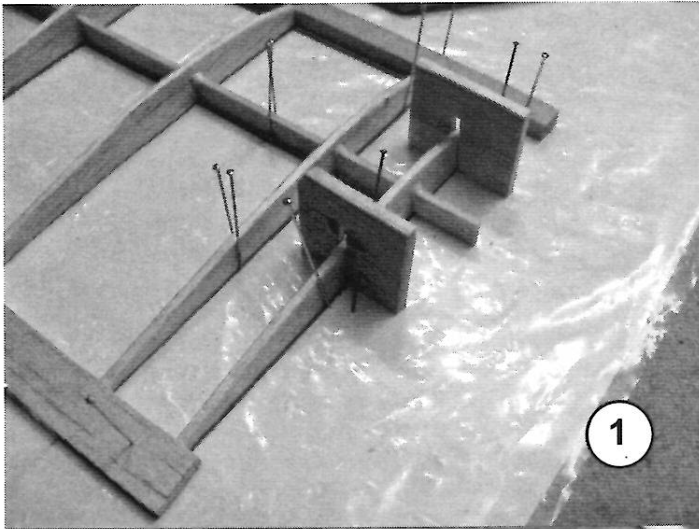

1. ROOT RIB SET AT 5 DEGREES WITH JIGS.
2. FINISHED WING TIP NOTE PIECE ON TOP OF SPAR.
3. STAB INSTALLED WITH OUT DT.
4. WING TIP INSTALLED ON TOP OF EXTENDED SPAR TO SET ANGLE.
5. STAHL TYPE CONSTRUCTION USED TO BUILD TAIL FEATHERS.
6. MODEL READY FOT TEST FLIGHTS WITH HEAVY GUILLOWS WHEELS AND NO DT.

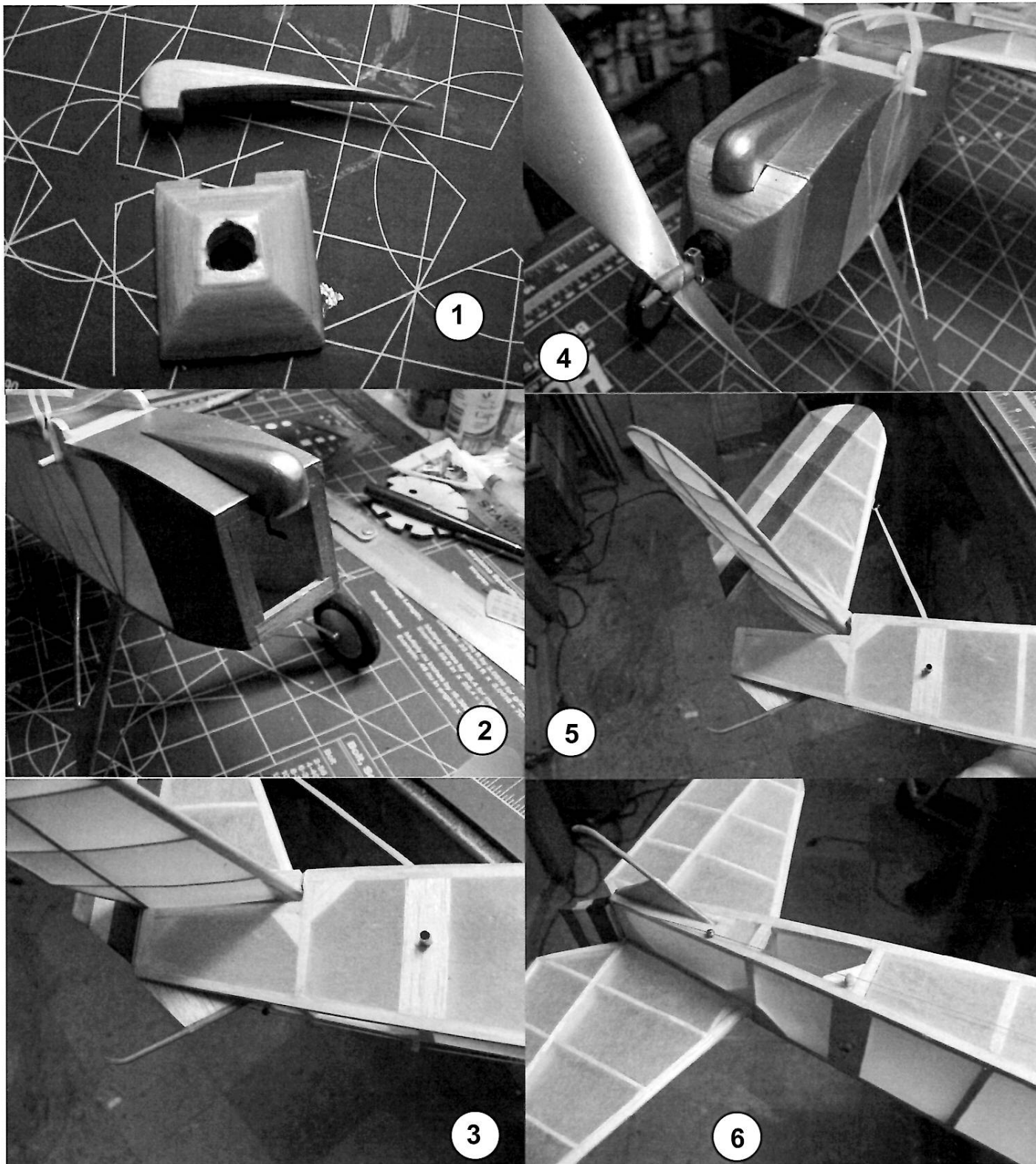

1. NOSE BLOCK DRILLED FOR GIZMO GEEZER AND DUMMY ENGINE.
2. NOSE WITH DUMMY ENGINE ATTACHED.
3. TAIL END SHOWING GUSSETS NOT ON PLANS.
4. NOSE WITH GIZMO GEEZER AND SWING CLUTCH.
5. DT OPERATED, IT GOES TO 45 DEGREES WITH A #12 RUBBER BAND.
6. THE LANYARD FOR THE DT HAS A BEAD FOR A STOP AND WRAPS AROUND A CAPSTAN TO REDUCE THE FORCE ON THE VISCUS TIMER.

MaxFax JUL-AUG 2013



D. C. MAXECUTERS
% STEW MEYERS
8304 WHITMAN DR.
BETHESDA, MD 20817

PRSR STD
US POSTAGE
PAID
PERMIT 6388
SUBURBAN MD

CONTENTS:

NAVY PURSUIT FROM JAN. 1934 FLYING ACES

CYANOACRYLATE POOP SHEET



2*26*****MIXED AADC 207

Mike Escalante
212 Division Ave
Hagerstown MD 21740-5040

OR CURRENT RESIDENT

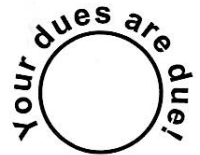

You can now renew on line!
Go to MaxFax on the website
www.dcmmaxecuter.org

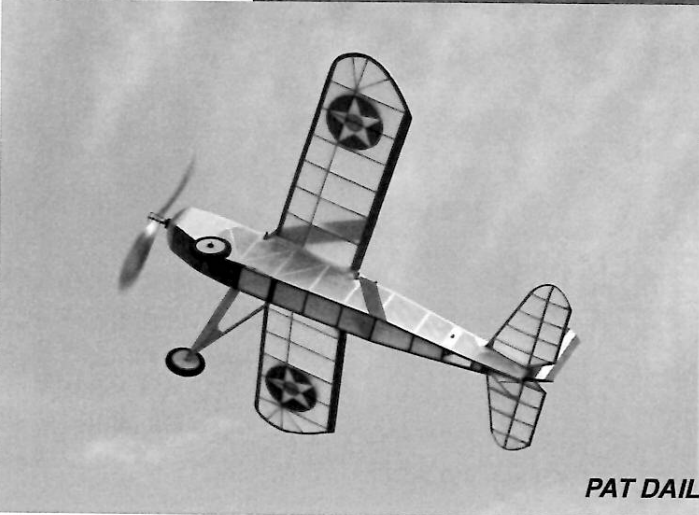
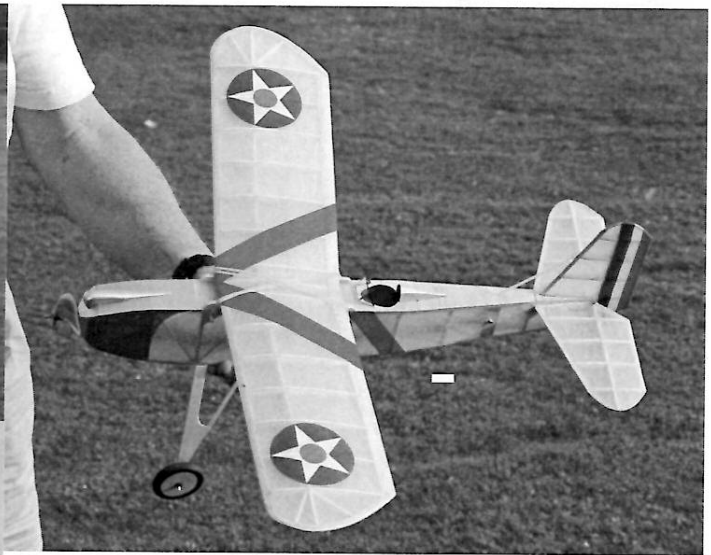

PAT DAILY POTOS

USE THE ORIGINAL FLYING ACES DRAWINGS FOR
DETAILS NOT SHOWN HERE..

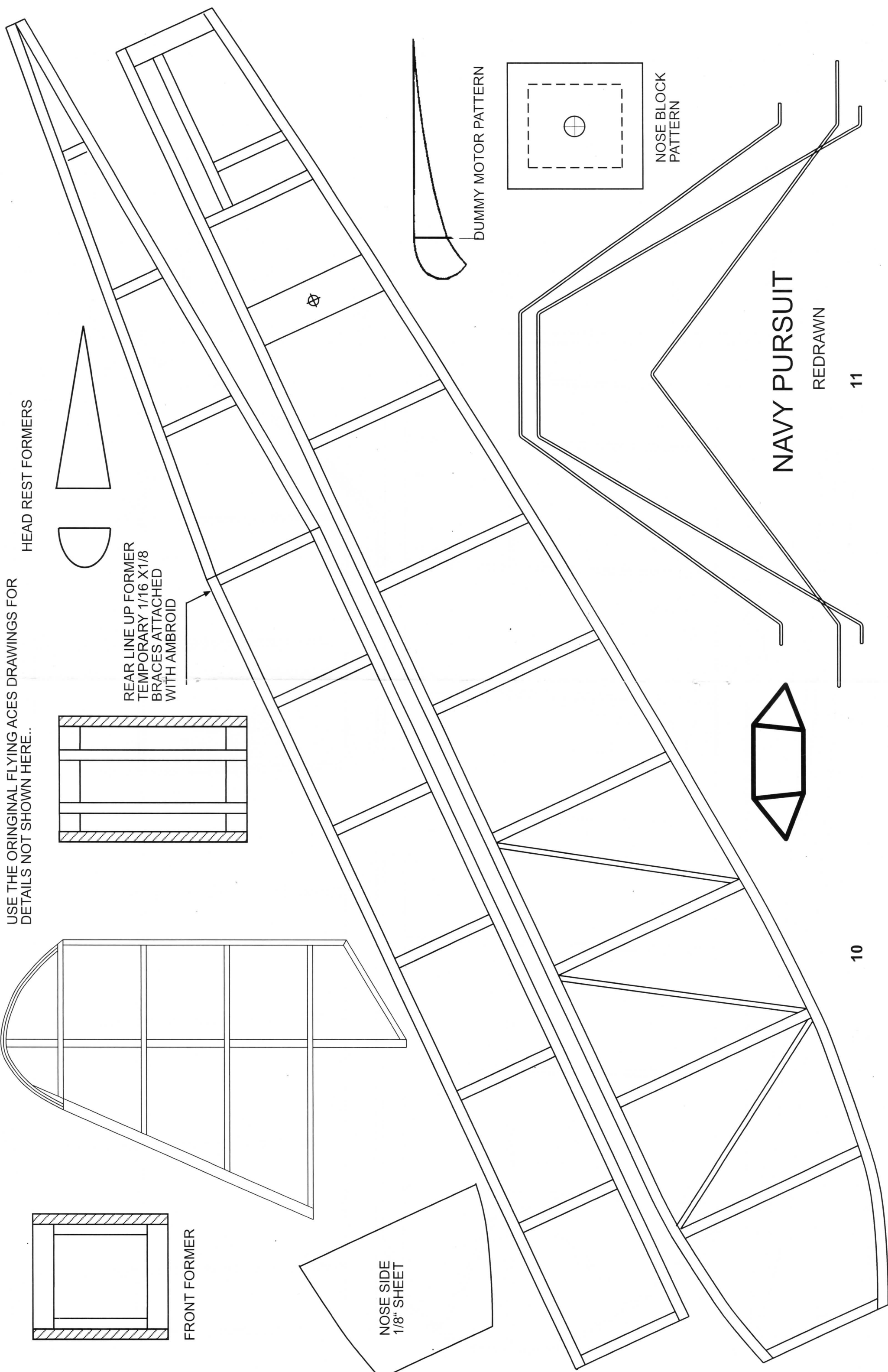

HEAD REST FORMERS

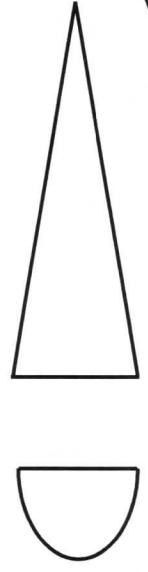

REAR LINE UP FORMER
TEMPORARY 1/16 X 1/8
BRACES ATTACHED
WITH AMBROID

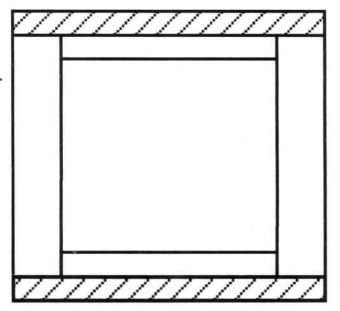
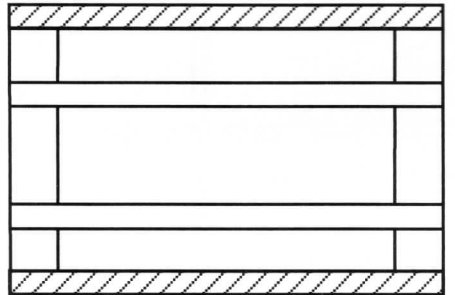

FRONT FORMER

NOSE SIDE
1/8" SHEET

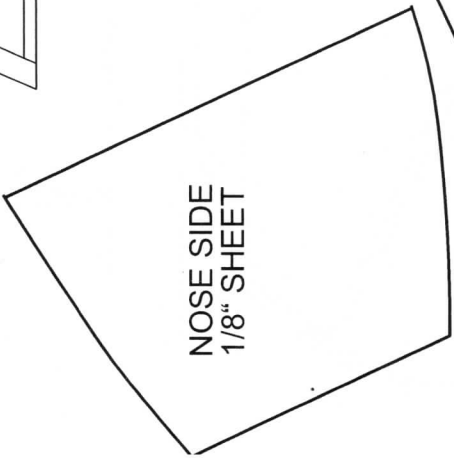

DUMMY MOTOR PATTERN

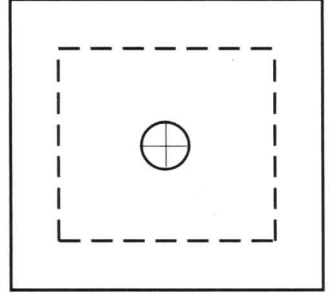

NOSE BLOCK
PATTERN



NAVY PURSUIT

REDRAWN

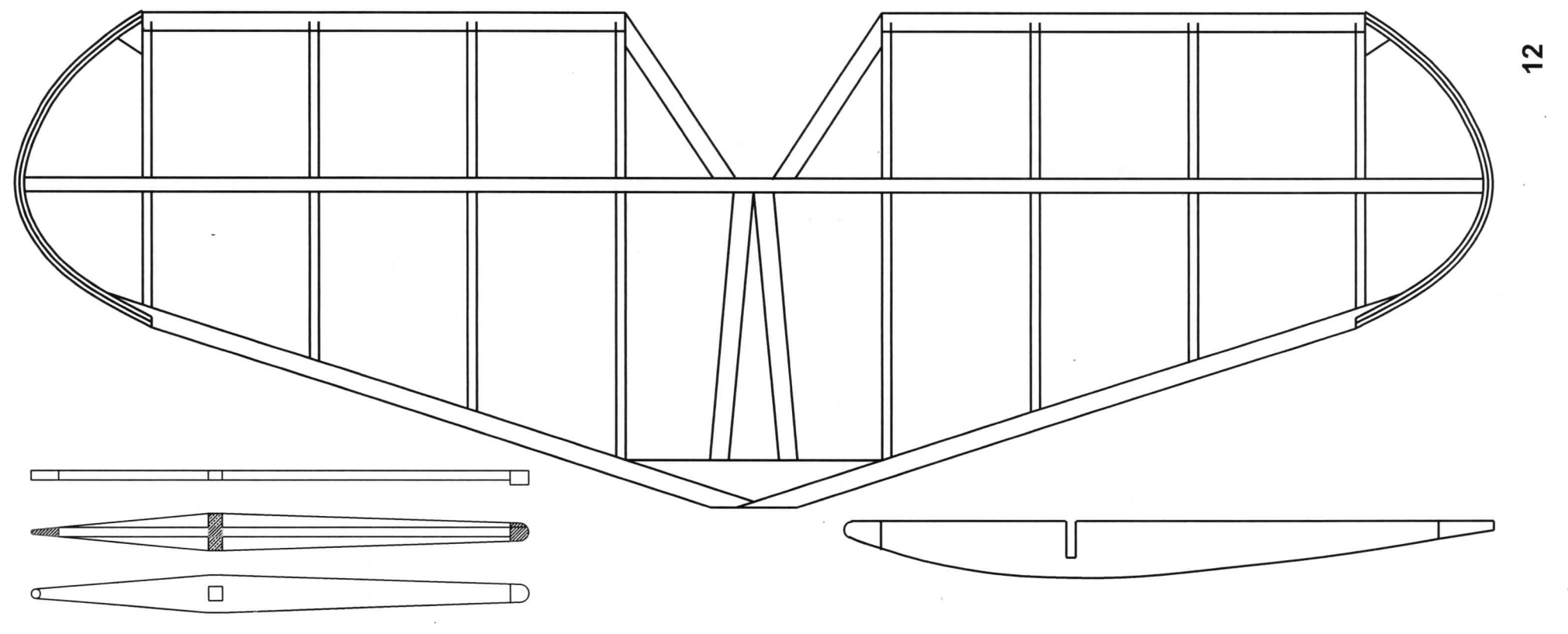
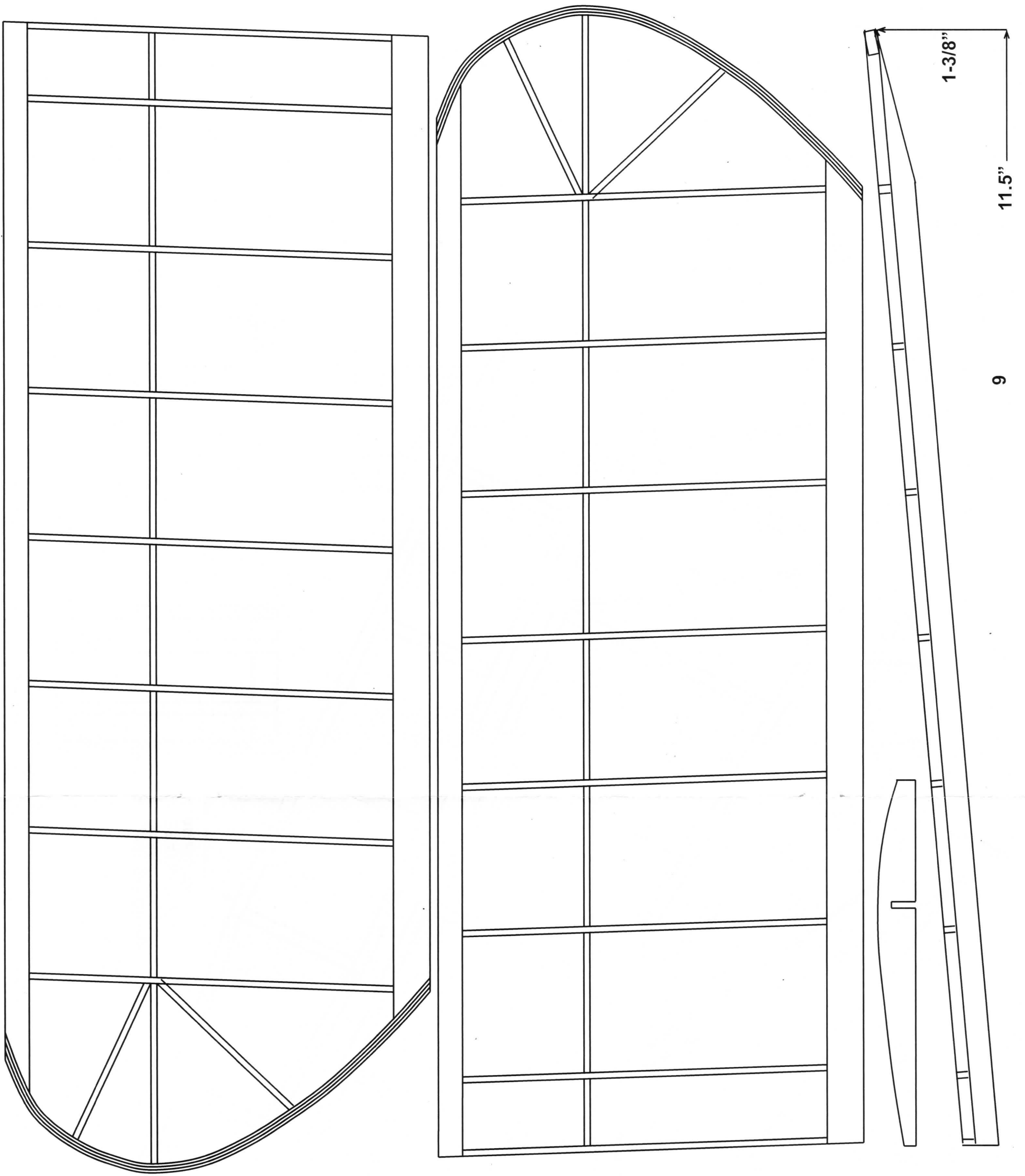

12