

# MAX FAX



Journal of the D. C. Maxecuters

... home of the dreaded POTOMAC PURSUIT SQUADRON of the Flying Aces

Editor: Stew Meyers

2013-5 (SEP-OCT)

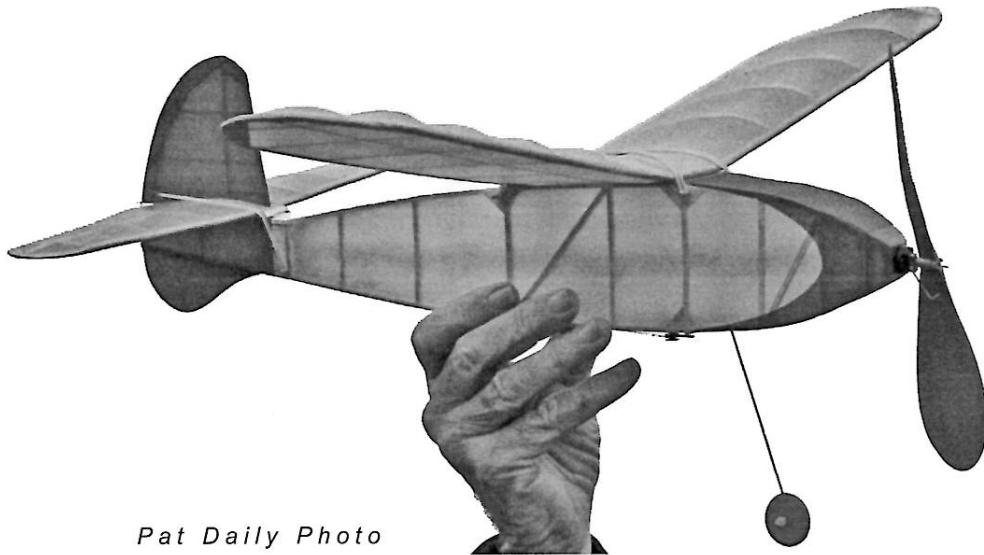

*Pat Daily Photo*

## KING HARRY ISSUE

### COMING ATTRACTIONS

We get together every Tuesday at 11:30am at Mylo's Grill for lunch.  
6238 Old Dominion Dr, McLean, VA

Bauer Community center is available for indoor flying Mondays and Wednesdays from  
12:45 to 2:15 PM during the school year.  
The address is 14625 Bauer Drive, Rockville, MD

DCRC sponsors indoor R/C flying at the Montgomery County Soccerplex. Indoor flying  
begins /27/13 and runs through 3/5/14 with the exception of /25/13 & 1/1/14. Flying  
is every Wednesday from 11:45 AM until 3:45 PM. Not really suitable for free flight.

NBM flying sessions Sunday January 26 and Sunday May 4, 2014.  
Details on page 6.

West Potomac High School Indoor Fun Fly - February 22nd, 2014  
6500 Quander Road Alexandria, VA 22307 8:00 AM - 2:00 PM Main Gym  
Joseph Franco WESTPotomac.engineering@gmail.com

The annual Kudzu Classic date set for May 17 --18, 2014. Raeford, NC

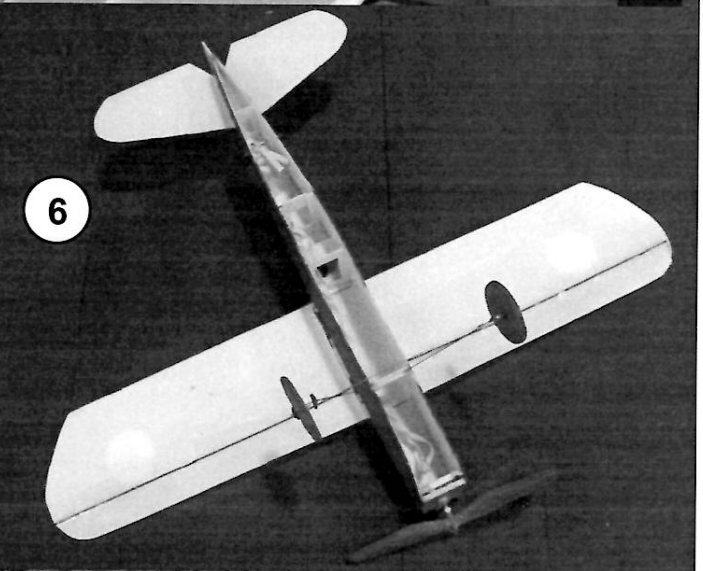
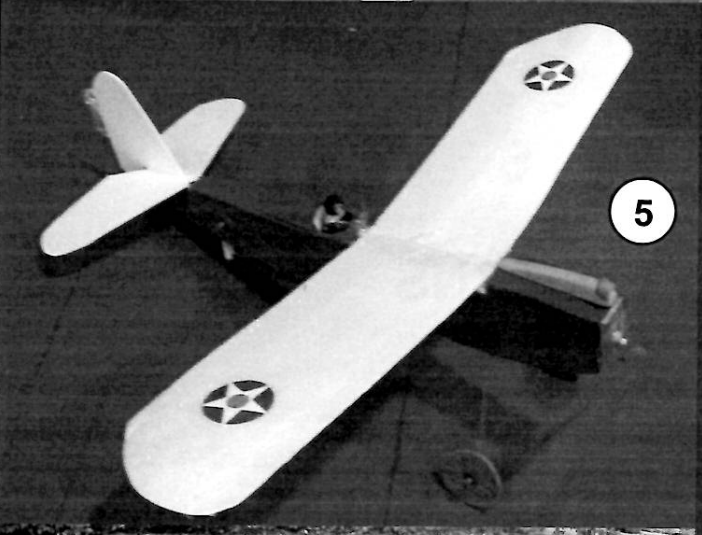
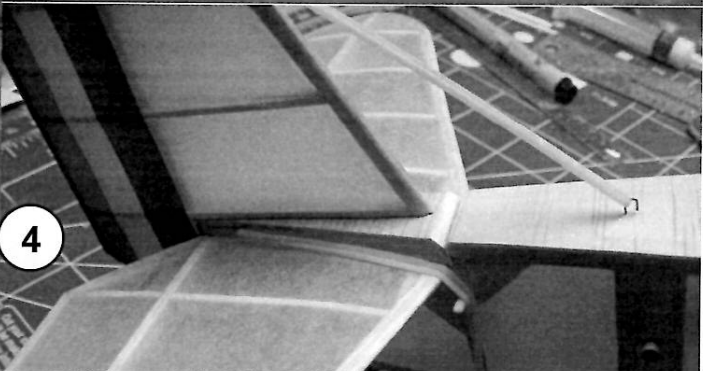
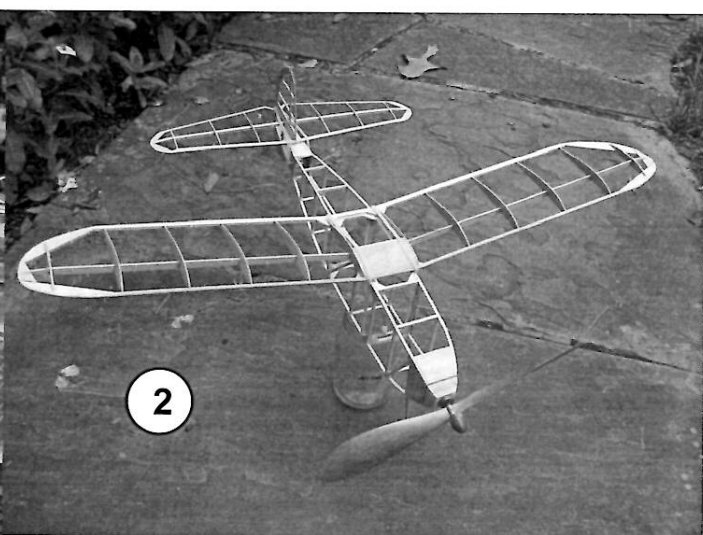
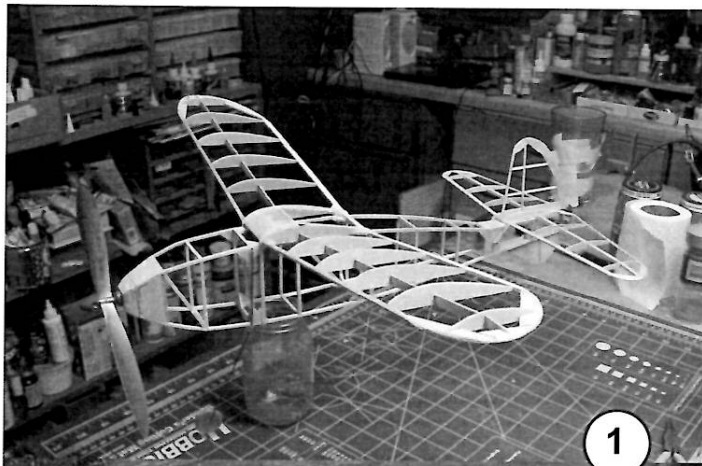

# MaxFax 2013- 5

(SEPT-OCT 2013)

Stew Meyers Editor

## King Harry and Prince Hal

After flying the Navy Racer from the last issue, I was looking for something a little less robust and more competitive. I came across a copy of SAM1066 at our regular Tue. lunch. In it was a reduced copy of the '45 AeroModeller drawing of King Harry. I liked the looks and remembered Paul Grabski and some of the Detroit Guys flying them. I went to <http://outerzone.co.uk/> and found it and Prince Hal. The drawing for Prince Hal indicated it was the center fold in the August 1995 AeroModeller. The earlier King Harry was published in the August 1945 AeroModeller, but was half size with the exception of the ribs. I found my copy of the August 1995 issue with the plan intact and am including the article in this newsletter. My sources don't extend to 1945.

Prince Hal is an update of King Harry with a removable two leg landing gear replacing the single stalk of King Harry and a slightly modified fuselage. The tail feathers are virtually identical. The wing purportedly replicates the corrected version of King Harry which was in the 1946 AeroModeller Plane Fare and indicated the wing was really 24.75" span. (I calculate 24.25" true span using the 2" dihedral which is never mentioned on the King Harry plan-- perhaps a error in the article.) Using the 12" semi-span shown on the KH drawing results in a true span of 23.8" with 2" (10 degrees) of dihedral.

I like the slightly chubbier appearance of King Harry on the half size plan and it's FAC legal, so I redrew the fuselage full size using the offsets shown on the plan. To my surprise the resulting drawing more closely resembled Prince Hal than King Harry. They joys of old plans! I then enlarged the half sized drawing of the King Hal fuselage to full scale and measured the offsets. They did not reflect the offsets shown on the plan. The drawing has the nose a bit more

### Photos Page 2

1. 2. 3. Bones shots of King Harry. In the end I used a Gizmo Geezer thrust button, but not the full mechanism, photos 7 & 8 show this.
4. Revised Navy Pursuit DT does away with the Sig hinge. I noticed flights had become rather variable and traced the problem to the fact that the Sig hinge had become torsionally weak and the tail could move around. This is just about as bad as a loose thrust button. A traditional rubber band hook up cures the problem.
5. 6. Joe Horton took the Navy Pursuit plans from the last issue and some 2mm Depron to whomp up Foamie NP. It weighs in at 48 grams and flew well on an indoor test flight. Not bad for a two night effort.

MEMBERSHIP - Dues for membership in the DC MAXECUTERS are **\$25** per year for residents of the USA, Canada, and Mexico, and **\$35** for all other countries. You may now use PayPal at the website: **[www.dcmaxecuter.org](http://www.dcmaxecuter.org)**

Your mailing label indicates the year and month of the last issue of your current membership. A red "X" in the box below is a reminder that your dues are due. Send a check, payable to the "D.C. MAXECUTERS", to the treasurer, Stew Meyers.

PUBLISHING DATES - Six issues of MaxFax are sent each year as close to the nominal dates as possible, but since this is a volunteer publication nothing is guaranteed except that six issues will be sent to all members. (*Rising costs and dwindling membership may force us to go to four issues a year some time in the future.*)

CONTACTS - Material for the newsletter and membership questions should be addressed to Stew Meyers phone 301-365-1749. Email gets immediate attention. [stew.meyers@verizon.net](mailto:stew.meyers@verizon.net)

bulbous, all the vertical offsets aft of the 1" square nose are slightly larger than shown. The sub fin shape is also just a bit different between the King and Prince. Remember to be FAC legal you need to build the single stalk King Harry with its short wing.

My King Harry weighs in at 38 grams with a 9 inch Peck prop. Three 32 inch loops of 1/8 provide plenty of power. I was gratified to find King Harry zoomed off the table so fast that the single landing gear leg is not a problem. On the first full ROG power test, it did a max. To my amazement it flew well on the first flight and required no trim except for thrust adjustment as more power was added. It flies in a right- right pattern.

I have had to rearrange the plans to fit the Tabloid size of MaxFax. To economize on space only the King Harry fuselage is shown full scale. Use the identical full scale fin and stab from Prince Hal. I have also shown how to mod the Prince Hal wing for King Harry. Full size unbutchered plans are on the Maxecuter website for both.

There is a review of PVA glues in this issue. I also share some thoughts on rubber power. Ray and I did not make it to WaWa as planned this year, but we have a Frank Rowsome report and Glen Simperts photos.

### The indoor season is upon us.

The DCRC sponsors indoor R/C flying at the Montgomery County Soccerplex. Indoor flying begins 11/27/13 and runs through 3/5/14 with the exception of 12/25/13 & 1/1/14. Flying is every Wednesday from 11:45 AM until 3:45 PM. Not suitable for free flight.

We fly both small R/C and free flight at the Bauer Community center Mondays and Wednesdays from 12:45 to 2:15 PM during the school year. The address is 14625 Bauer Drive, Rockville, MD.

NBM flying sessions Sunday January 26 and Sunday May 4, 2014. details on page 6.

**BUILD FROM  
PLANS  
OUR FULL-SIZE**

**If you fancy a  
little rubber  
model with a  
vintage parenthood,  
then try this charmer  
by Alan Wiggs**

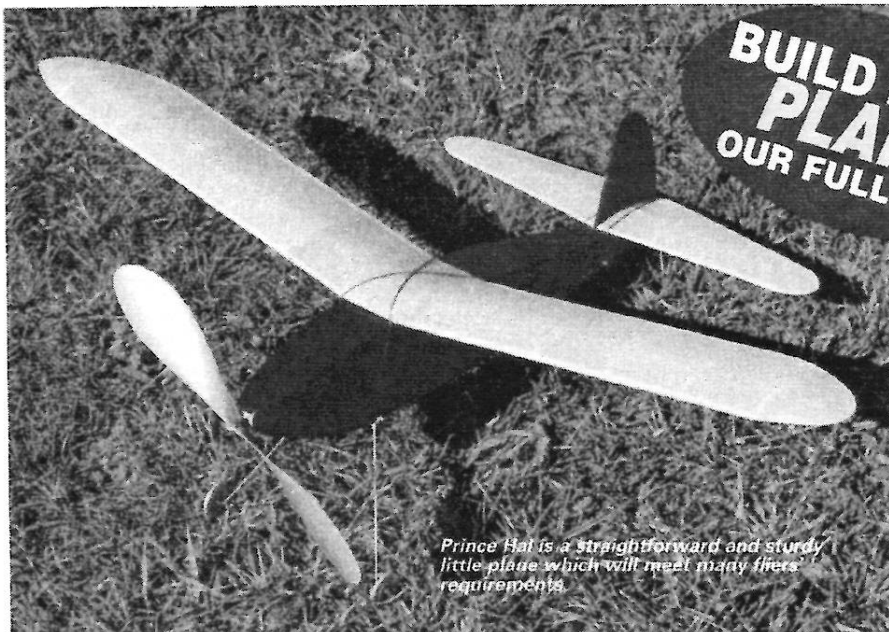

*Prince Hal is a straightforward and sturdy little plane which will meet many fliers requirements*

# PRINCE HAL

## King Harry

This design was first published as King Harry in *Aeromodeller* fifty years ago this month as a half-size drawing omitted some details. Subsequently the 1946 *Aeromodeller* Plan Fare repeated the plan and helped a little by reporting that the span was in fact 24 3/4". In the full size plan we now publish I have created the missing details and included a few modifications. So Prince Hal is a natural successor but cannot truly claim to a copy of King Harry. It is an outstanding performer for restricted flying sites and it should give equal satisfaction to beginner and expert alike.

## Fuselage

Cover the plan with cling-film and start building. Select the two strongest lengths of 3/32"sq you have for the longerons. You might need to steam bend the lower one. Pin the wood over the plan, placing the pins either side and not through the wood. Take particular care to ensure the wing and tail platforms are true. Cut the vertical spacers and glue in position, then the diagonals. Finally add the sheeting to the nose and rear motor peg and the gussets. Construct the second fuselage side over the first one. Either use cling film between the sides or carefully slice them apart with a very thin blade when the glue is set. It is advisable to provide some reinforcement round the motor peg hole, which can be a disc of ply or celluloid. Prepare the card formers AA and BB, notching the corners to take the longerons. Then proceed as per instructions written on the plan.

## Wing

Make card templates for the ribs, wing tips and dihedral brace. Cut out the 12 ribs from 1/16" sheet, pin into a block and sand the outline smooth. To make the shorter tip ribs, take two of the ribs already cut and trim to

length and profile as shown dotted on the plan. Another rib makes a good template. Be sure there is sufficient length at the rear to lap over the 1/16" tip outline.

Prepare the 1/4" x 1/16" for the spar and trailing edge. The spar needs a small piece cut away on the underside at the centre section, to give the dihedral angle. This triangular scrap can then be glued on top of the spar to give a hockey stick effect. At the other end of the spar a 1/16" notch on the underside fits over the tip outline.

Pin the trailing edge on the plan and using strips of 1/16" sheet, 1/2" wide, build the tip outline. Glue the rearmost two, but leave the front one till the leading edge is in position. Place the ribs on the spar and locate over the plan, pinning in position. Glue the ribs, making sure to use the dihedral template to set the root rib at the correct angle. Fit the leading edge and glue in the front piece of the tip material, which has its front edge chamfered 45 degrees to fit under the leading edge. Finally add the 1/16" gusset to the root rib. When dry, remove from plan and shape the tip outline using the template.

Build the other wing in a similar manner. Set

the wings up on a good flat board with 2" under each wing tip. The two "hockey stick" projections should rest flat on the plan and meet at the centre line. Secure the wings with pins through the root gussets. Add the centre section leading edge, trailing edge and sandwich the hockey sticks with two pieces of 1/16" sheet for the full depth of the ribs. When set cover with 1/32" sheet. To assist forming this shape, lightly dampen the top surface. The underside can be covered with stiff writing paper.

## Tailplane & fin

Make card templates again as necessary. Pin down the material for the tail outline. Lap the joint where the leading edge meets in the middle; this is stronger than a butt joint. Fit the centre spar. The ribs are adjusted to size by the "falling trailing edge method" as show for the wing, and notched over the spar. When fitting the centre pair of ribs, space the gap between them with 1/16" scrap and check that they are vertical. When dry shape the tips and sand the leading and trailing edges to section.

Pin down the fin commencing with the 3/32" leading edge and then the outline from 1/2" wide strips of 1/16" sheet. The base F2 should be of harder material as it has to support the fin in the tail. Build up the centre with 1/16"sq. When dry trim the outline to shape and check for fit in the tail. Use the template to cut the sub-fin, notch for the peg and glue to the fuselage underside.

## Undercarriage

For a normal fixed undercarriage take the 18g wire and bend it to fit inside the fuselage at upright No 4 and bind in position. For the detachable undercarriage fit

*An attractive model for all ages and Alan's simple red and white colour scheme suits it well.*

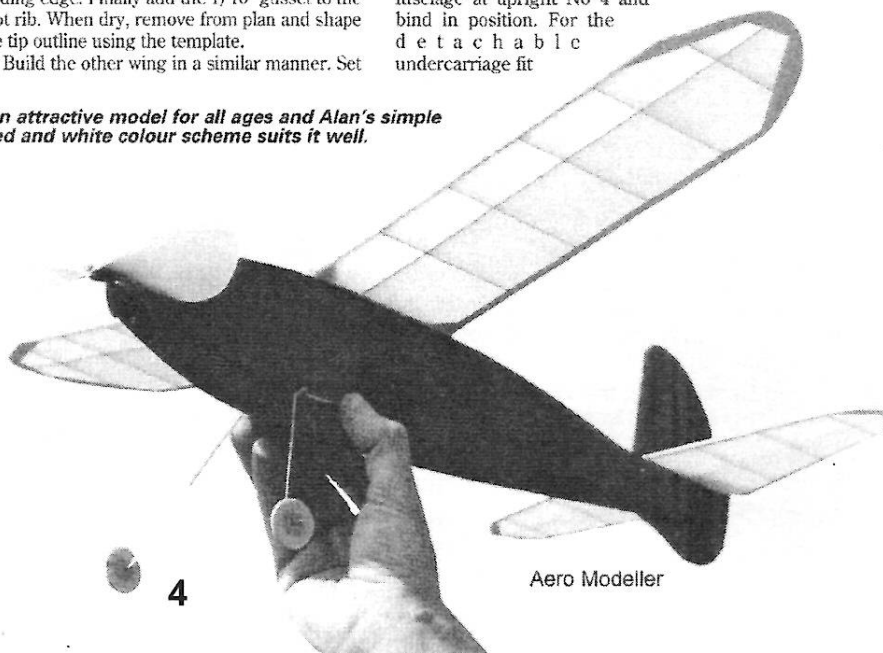

the 18g aluminium tube beside upright 5 and a 3/32" bamboo dowel in the bay forward of this. Start by bending the 18g wire with a 1/2" spike to fit into the ali: tube. Now measure forward 13.4" from this bend and turn the leg out at an angle. Cut to length and bend out as an axle for the 1" wheel. Bend a second leg to the opposite hand. In use the leg spikes are plugged into the ali tube and the legs are held against the bamboo peg by rubber bands passing underneath the fuselage. This gives extra spring to the u/c and it can be detached when the model is packed away.

### Noseblock & prop

Make up the noseblock 1" x 1" x 1/2" and drill a hole in the centre to take the 18g tube. Cover the rear face with 1/6" ply and also another small piece in the front to secure the tube. Take the off-cut from the centre of the ply fuselage former and glue to a piece of 1/8" sheet. Drill the centre for the 18g tube and glue to the rear of the noseblock. This will locate the noseblock in the front of the fuselage. There are two plastic props that can be used on this model if you do not want to carve one - both incorporate a freewheel device cast into the hub. The 9.1/2" Peck is already drilled 18g, the Keil Kraft 7.1/4" may need the hole enlarging.

### Covering

Cover with a lightweight tissue and for adhesive use tissue paste or PVA thinned with water. Commencing with the underside of components, apply the adhesive to the edges only. Stretch the tissue lengthwise, then work out any slack. The top of the

tailplane should have separate sheets for each half to allow for the camber of the ribs. The top of each wing half requires three pieces of tissue. One to cover the first 4 bays, then two separate pieces for the tip. Paste the ribs where these joints take place and allow to dry before fixing the next piece. On completion, spray with water and leave overnight to dry slowly. Never apply heat. Check for warps and apply a coat of shrinking dope diluted 50%. The covering will again go slack as it dries any warped parts can be placed on a flat surface and weighted down. If possible leave for several days until it has really set.

### Flying

Ballast will probably not be necessary as the wing can be moved a little, but should not be more than 1/4" from the position indicated. Try gliding on a calm day. If the model dives move the wing forward. If the model zooms and stalls, move the wing back. Make these adjustments no more than 1/8" at a time. When launching these tests use a smooth push, not a throw. When the glide is OK try a few turns and correct the flight with small thrust line changes by packing the nose block. Trim is right under power and right glide. With the 7.1/4" prop this needed slight right rudder and 1/32" packing on the left hand side of the noseblock. Flight tests were done with a 15" loop of 1/4" rubber which will also do for the 9.1/2" Peck prop, For the 10" balsa prop use 4 strands of 3/16" rubber and the noseblock will require down and sidethrust. Three or four hundred turns should be enough for a good flight.

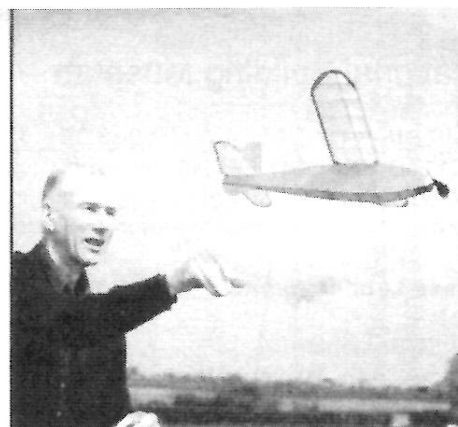

*Prince Hal at Old Warden being put through its paces for the camera by the designer.*



*Alan is pleased with his version of this design which was originally called King Harry and published in the Aeromodeller 50 years ago.*

Here's a good summation on sizing rubbers motors by Gary Hinze on the FF Mailing List forum.

Sizing rubber motors is about balancing conflicting requirements. A rubber motor must meet all of several requirements:

**Weight.** Rubber is the source of the energy that lifts the plane. Duration is directly related to the amount of energy carried. So you would want the maximum weight of rubber you can get. But more weight also makes the plane come down faster. The duration trade off on weight occurs when the motor weighs twice the weight of the airplane. You will almost never get there, because one of the other requirements will restrict you to a smaller motor. In competition, rules will limit the weight of the motor to much less than this.

**Length.** A longer motor will take more turns for more duration. The motor must fit in the fuselage, it must fit between the propeller hook and the motor hook or peg. This may be the tightest limit on motor weight. You can make the motor longer than that distance, but only up to a point. You will find that when you get up around twice that distance, you will have troubles managing the motor. When you wind a very long motor and bring it in to fit between the hooks, it will ball up into a tangle. It will not unwind properly. It will jam on the stick or inside the fuselage. It will tangle all over the prop hook and jam it. Once it unwinds a little, it will hang down, no longer aligned with the prop shaft so it will not turn the prop. Braiding the motor will tighten it up a little and will allow you to get a little more rubber into the available space.

**Cross Section.** Cross section determines turns per inch capacity. Thinner motors can take more turns per inch, giving more propeller revolutions. Cross section determines torque. Greater cross section will produce higher torque values. A certain amount of torque is required to fly the plane. Torque required depends on the aircraft and propeller aerodynamics. Cruise torque, the torque to fly level, is a good indicator. In still air, cruise torque should occur at somewhat over half of maximum turns, maybe in the vicinity of 60% to 70%. (If you set maximum turns below breaking turns, cruise torque point should be reset.) The exact location depends on the shape of the torque curve for the particular batch of rubber used. (Or on the shape of the remaining curve if you set a maximum lower than breaking.) Cruise torque depends on the total weight, including the weight of the motor. Cross section is related to the other quantities because cross section times length times density equals weight. High torque also may produce undesirable rolling, which must be compensated with aerodynamic adjustments; dihedral, rudder, thrustline, aileron. Continued on P-9

## National Building Museum – 1/26/2014

BUILDING OF DELTA DARTS (8:30 – 11:00)

FLYING EXPOSITION (11:00 – 4:00)

Note that some of the events have minimum weight limits, so please prepare your models accordingly.

### Mass Launch Events:

12:30 Bostonian

14g. Minimum Weight without rubber – ROG

1:15 Parlor Fly

Plans on web site

2:00 WW-II No-Cal

6 g. minimum weight without rubber

2:45 Dime Scale

FAC Rules

3:15 Phantom Flash

FAC rules – plastic prop – ROG

### Timed Events

(to be flown throughout the day 11:00 to 4:00):

Peanut Scale (Judged at the Head Table)

FAC rules

Zaic Z-15 (a simple tissue covered model )

Plans on web site

Limited Pennyplane

AMA rules: Pennyplane (3.1 g. min. w/o rubber, not more than 20 in. long, projected wingspan no more than 18 in., 10 in. max. motor stick, direct drive rubber motor ) further limited by a wing chord no more than 5 in.; horiz. stab no more than 4 in. by 12 in.; motor stick must be solid; prop. dia. limited to 12 in.; no gadgets (variable pitch prop mechanisms, etc.); wing must be monoplane.

A-6 plans and rules on web site.

No-Cal 6 g. minimum weight without rubber

### NBM NOTES:

There will be two trophies awarded in Phantom Flash. One for the overall winner and one for highest score by someone who has never won the event at the NBM before (if different).

Airplanes that have won twice before at the National Building Museum cannot further compete and must be retired to exhibition and fun flying only.

Certificates will be awarded to those who have exceeded one minute in flight or have risen above the 4th floor catwalk and safely returned to the floor.

Youth fliers should check in at the head table to be instructed in the flying protocol for indoor flying (clear the floor after launching; no running; don't pick up another's model).

Grand Champion calculation: The points awarded to a flyer will equal the number of flyers that finish behind the winner in any given event.

### RC ATRIUM EVENTS:

FLYING EXPOSITION (11:00 – 4:00)

1. Tortoise and Hare Event for the slowest flying model to complete a figure eight.
  2. Mini Vapor Combat.
  3. Mini Vapor Race
  4. Most Unique/Creative RC model to complete a figure eight.
  5. Most Beautifully Crafted Non-ARF Foam Model to complete a figure eight.
  6. Most Beautifully Crafted Non-ARF Balsa-Tissue Model to complete a figure eight.
- Free style flying between events.

Paul Stamison will run the Radio Controlled events.

Send Glen Simperts a note before 1/21/14 if you desire entry to the museum before 11:00. Your note should include all names in your party and have names as they appear on your driver's license.

Glen Simperts [grfreeflight@hotmail.com](mailto:grfreeflight@hotmail.com)  
301-843-2896

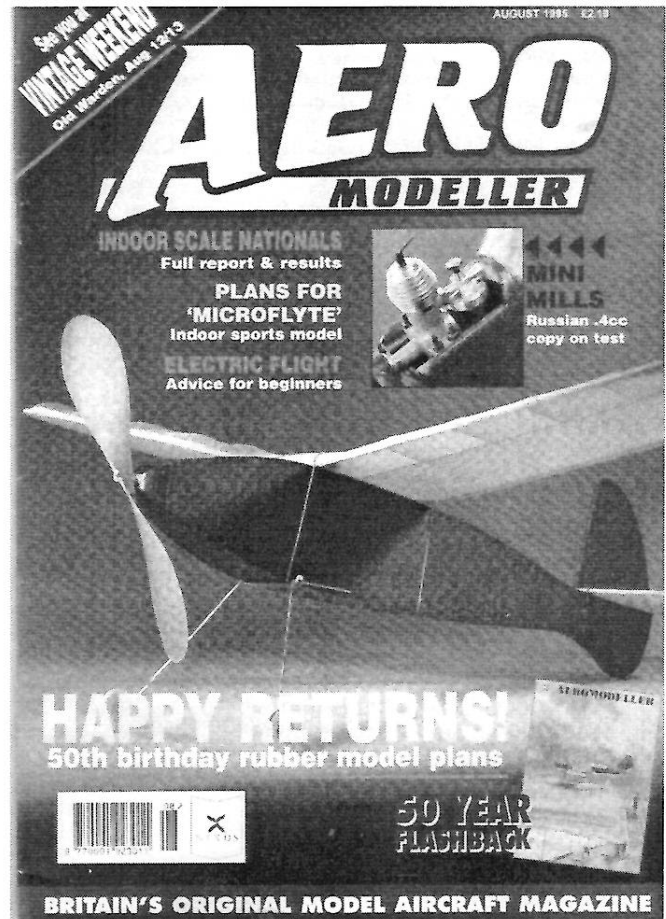

From Aug '45 Aeromodeller

**"KING HARRY"**  
DESIGNED BY  
K. EDGERTON.

PROP 10 DIA CARVE FROM  
HARD Balsa 10 x 1/16 x 1/16  
10 SW 2 SHAFT WITH FREEWHEEL

POWER: 4 STRANDS 3/16 x 1/20 - 20' LONG  
OR 6 STRANDS FOR FASTER CLIMB.  
WEIGHT: 1.75 OZS. AVERAGE DURATION 70 SECS.

CEMENT 1/16 DIA BAMBOO THRU FUSELAGE  
TO HOLD RUBBER BAND SECURING  
NOSE BLOCK.

SCALE: 1/2 FULL SIZE.

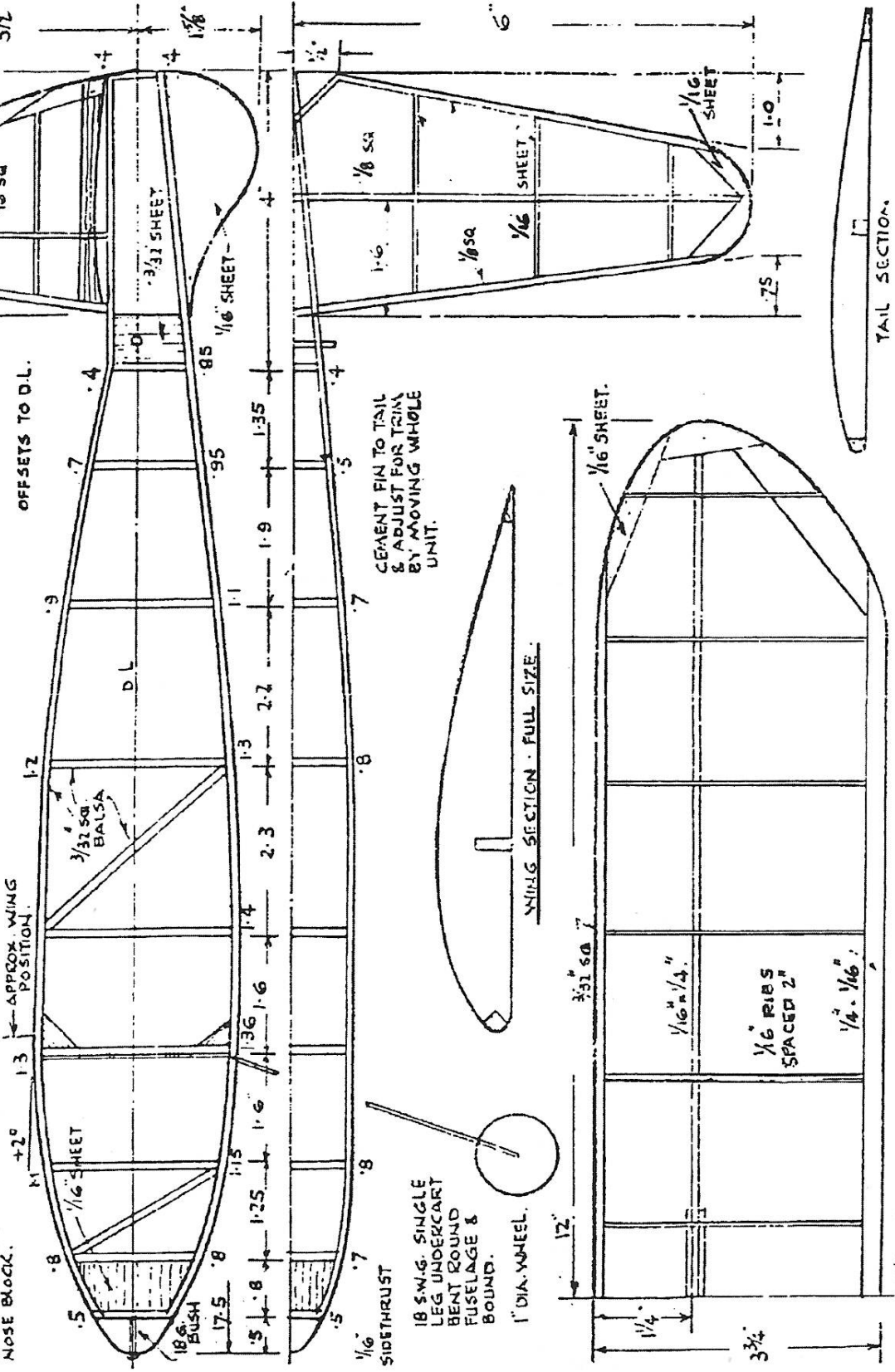

OFFSETS TO D.L.

APPROX. WING POSITION.

CEMENT FIN TO TAIL & ADJUST FOR TRIM BY MOVING WHOLE UNIT.

WING SECTION - FULL SIZE.

TAIL SECTION.

18 SW.G. SINGLE LEG UNDERCART BENT ROUND FUSELAGE & BOUND.  
1" DIA. WHEEL.

**BONUS PLAN**

The "King Harry" is a vintage design by K. Edgerton that was originally published in Aeromodeller magazine in Aug of 1945.

It qualifies for FAC Oldtime Rubber but not for SAM OT events. According to the gang in Detroit, it's a good flyer!

TEMPORARY  
CARD FORMER  
B-B  
USE WHEN  
JOINING  
FUSELAGE  
SIDES

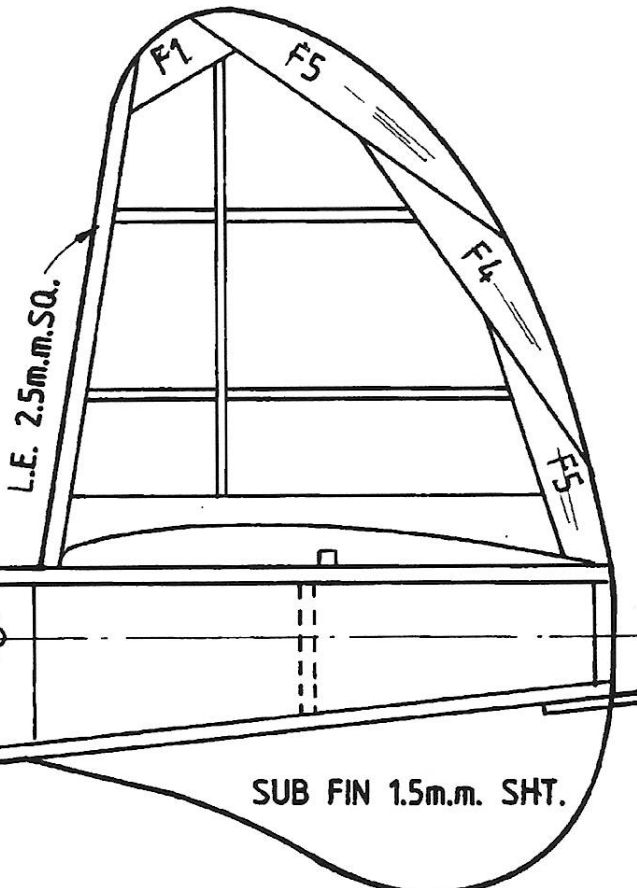

REAR MOTOR PEG  
2.5m.m.DIA. BAMBOO

PEG FOR RUBBER BAND  
TO HOLD TAIL

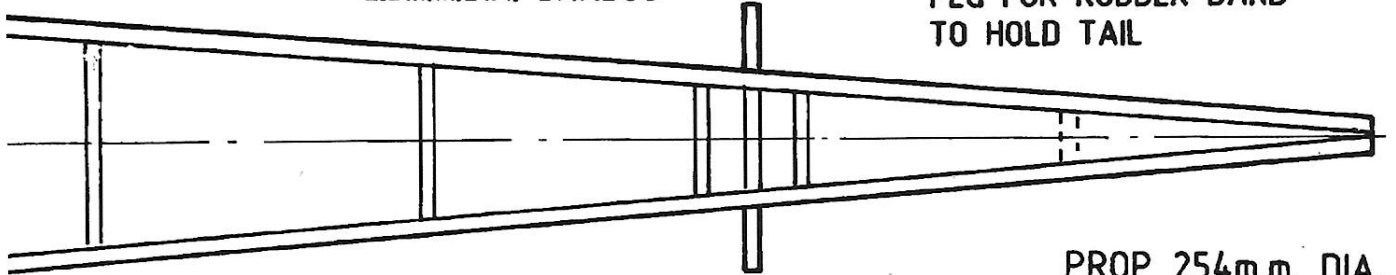

FRONT VIEW

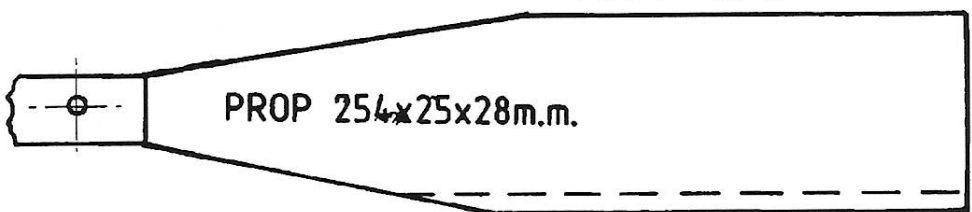

PROP 254m.m. DIA.  
BALSA AS SHOWN  
OR FINER PITCH  
254x32x25m.m.  
18s.w.g. ALI. BUSH  
WITH FREEWHEEL

POWER: 4 STRANDS 4.5m.m. TAN RUBBER UP TO 20" (500m.m.) LONG.

WEIGHT OF ORIGINAL MODEL 1.75ozs. (49gm.)  
AVERAGE DURATION 70secs>



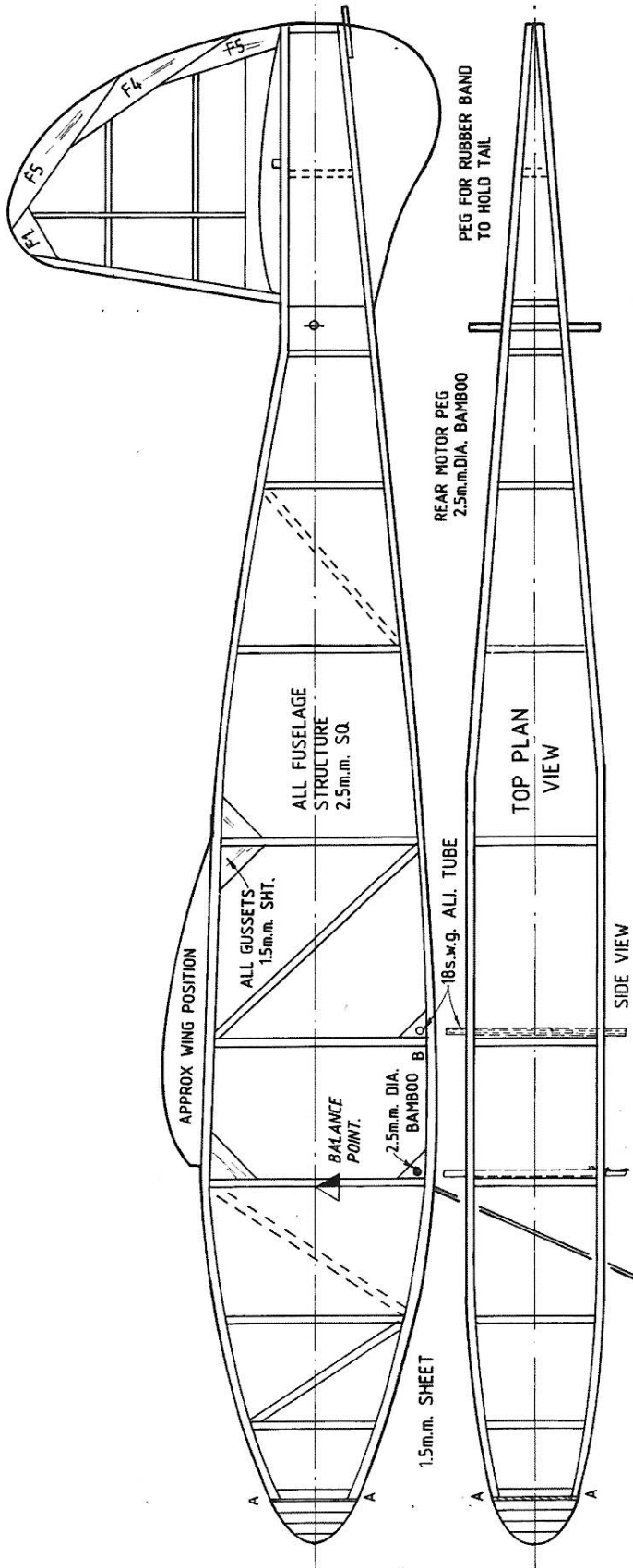

THESE HALF SIZED STUDIES ILLUSTRATE THE DIFFERENCE BETWEEN KING HARRY AND PRINCE HAL. THS FINS ARE THE SAME BUT THE SUBFINS AREN'T. EVIDENTLY HAL WAS DRAWN UP USING THE OFFSETS WHICH DON'T QUITE REFLECT THE DRAWING.

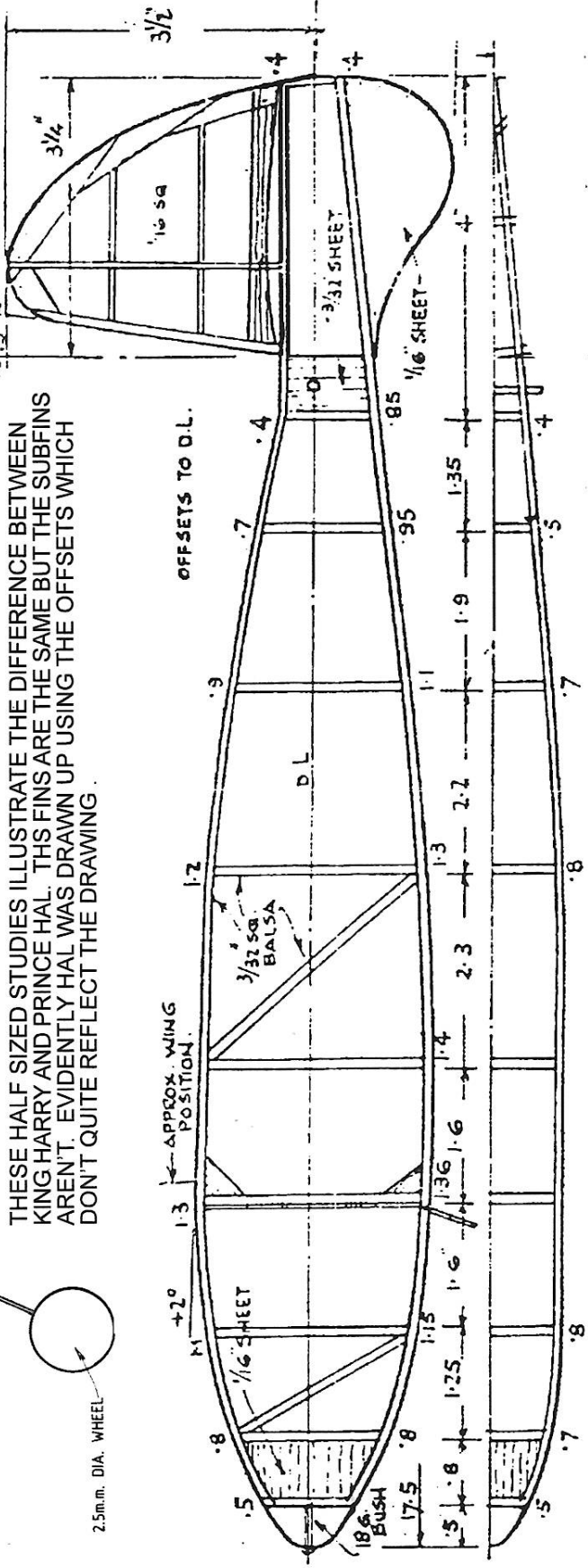

## Glue Two - The PVA's

Stew Meyers

In the last issue I included a rather extensive rundown on Cyano Acrylics. I had previously given the history of Ambroid and some hints about using it in the MAY-JUN 2012 issue of MaxFax. To reiterate, Ambroid (or Duco for that matter) is a solvent based glue. The best joints are made by "double glueing" the joints. Start applying a layer of Ambroid to both sides of the joint. This application of glue soaks into the wood fibers and is allowed to dry. When you make the joint, apply a second layer to one side and stick the two sides together. The solvents will partially dissolve the glue that is in the wood and form a bond. Ambroid and other solvent based cements are more flexible than Cyano.

This time we will look at the other major choice for assembling models polyvinyl acetate (PVA), also known as "white glue". PVAs are non-toxic and very easy to use, but hard to repair since nothing else sticks well to the hardened glue. (Ambroid will stick to Cyano.) Remember you have two distinct adhesive systems here that are not compatible. Get dried PVA glue on balsa and Cyano and Ambroid won't stick to it. Likewise a coat of Cyano or Ambroid will keep a PVA glue from adhering.

Aliphatic resin glue is chemically similar to PVA (white glue), but it is chemically modified to make it stronger and more waterproof. It is typically a buttery yellow color and is sold as "carpenter's wood glue." TiteBond II is what I use. It has an open time of 5 minutes and takes about 15-30 minutes to set and it sands reasonably well, although it does sometimes gum-up the sandpaper if you use too much. The fast set of an aliphatic resin glue makes it better than a standard PVA type white wood glue, giving a stronger bond, faster, while allowing easy clean up of spilled aliphatic adhesive with a damp cloth before it dries. What about TiteBond III and the "original" TiteBond? TiteBond III has been modified to be more water resistant --almost water proof. It has a longer open time of 10 minutes and therefore a longer set time. It's not quite as tacky as TiteBond II and leaves a dark glue line. I wouldn't use it except for seaplane hulls. The "original" TiteBond appears to be a straight PVA with less tack and water resistance than TiteBond II.

TiteBond II is stronger than Ambroid. A good TiteBond II joint is stronger than most woods - orders of magnitude stronger than balsa. Ambroid is a little stronger than balsa and fine if that's all you are gluing. For spruce, bass wood, and ply wood TiteBond II is a better bet. Working with Ambroid and TiteBond II (or other aliphatic resin glues) is different. Although some of the techniques from Ambroid can be used. TiteBond II is water based and it really only requires a thin layer. The double glueing trick works with TiteBond II. Make the initial application of glue to both pieces to be bonded, wipe off all the excess and let it set for about 5 minutes. Then apply a very thin layer to one part- it will grab almost instantly. Give the joint about 5 minutes and you can file it. Don't stress it for 30 minutes or more. Maximum strength requires several hours. TiteBond II also shrinks as it cures. On a properly made

joint, the shrinkage can actually pull the joint tighter.

I use three methods to apply TiteBond II. I put a little pool on a plastic lid and dip the end of a balsa strip into it before a sticking it in place. I may also apply TiteBond II with a tooth pick dipped in the pool. I fill a hyper dermic syringe that has a 0.032 id tip with TiteBond II. I use this as I would my squeeze bottle of thinned Ambroid. I also have a plastic 35 mm film can filled with TiteBond II thinned with water. I use this with a brush or Q-tip for filleting and applying tissue.

Ambroid joints can easily be undone with MEK or acetone. One good reason for using it. After it cures, TiteBond II is water resistant and can't be readily debonded with water. Solvents won't phase it. TiteBond II is also thermo plastic and can be heat bonded. You can put a layer on the edge of the ribs, and a layer on the sheeting opposite the ribs. Then just put the sheeting on and heat it with an iron. TiteBond II will polymerize and bond the sheeting to the ribs. You can also loosen a TiteBond II joint by the application of heat.

Another variation of aliphatic resin glue, the Super'Phatic brand is marketed by Horizon and Balsa Products. It is a thinner, highly penetrating aliphatic that has the same properties as the standard aliphatic resin glue, but is water thin and penetrates with a "wicking" action for close fitting pre-assembled joints like a thin Cyano. However it takes 10 minutes to bond rather than 10 seconds. It is waterproof when set and produces tougher (more flexible) joints than cyano. It also has some of the drawbacks of thin Cyano. Get too much on a joint and you get a flash of dried glue that's the very devil to sand off. If the joint isn't tight fitting, you get a lousy joint. It does have a shelf life; eventually, it will turn brownish, and become slow to set. I just used some dated 2005 and it worked fine. That being said, if you build tight structures and are allergic to the fumes from Cyano, it may be what you want. Just remember, once you use it you are committed to PVA assembly.

The next PVA type adhesive I would like to mention is Weldbond. It's a little different. The manufacturer, Frank T. Ross & Sons Ltd is a little cagey about what it is chemically and merely says Weldbond is a PVA (Poly Vinyl Acetate based adhesive). My guess is that it is not an aliphatic resin emulsion. It's white and has some unique properties. For instance the manufacture states: "Weldbond can quickly be dissolved with acetone. Because Weldbond is water based it can also be dissolved with a soaking of, or submersion in water. This will dissolve a bond." -I tied it and acetone works! Not speedily like a solvent based cement, but eventually.- "The set up time for tackiness will vary with humidity, but is roughly five minutes for most projects. It will be somewhat longer in humid conditions. Weldbond becomes tacky quickly and will dry within the hour on porous surfaces. It provides a strong bond within 24 hours and full strength within a few days. Most bonds can be made without the need of clamping, unless working with materials that are bent or warped. It dries transparent. Glue joints will practically disappear and any excess material can be wiped up with a damp cloth up to 20 minutes after application. Weldbond provides a

flexible bond. Joints can be made on flexible materials without the danger of cracking or breaking when a project is moved. A sealing mixture of 5 parts water to 1 part concentrated Weldbond dries in approximately 1 hour, and can be used to increase the flexibility and strength of porous and soft wood, such as balsa. The wood is much less likely to split, particularly when it is being shaped. Two coats of the sealing mixture can be used, if necessary. This adds negligible weight to the balsa and when dry, makes an excellent primer."

What the manufacturer didn't say is liquid Weldbond can be dissolved in Ammonia(or Windex). (TiteBond II, by contrast, will curdle in ammonia.) Why would you want to do that? Well ammonia softens the lignin in wood. This is a great aid in laminating outlines. Years ago, I was tipped off to the fact that by brushing thin strips of balsa or bass wood with a 60/40 mixture of ammonia and Weldbond, they will become much more flexible. You only need to soak it for a few minutes, before you stack up the laminate strips. Then squeegee off the excess glue with a paper towel and pull it around a waxed form always keeping the stack in tension. I use masking tape to hold it to the form. It will usually cure within the hour to the point it can be removed from the form. It continues to develop strength overnight. A micro wave can speed up the process, but may transfer too much wax from the form to the lamination making it hard to glue to. Despite the laminating being done with a "PVA type" glue, the finished piece can be glued to the next assembly with Ambroid or Cyano as well as white glues. I keep a 35 mm film can filled with the Weldbond - Windex mixture ready for quick laminating. I'll confess I don't use Weldbond for much else, but this feature alone is worth the effort. I do find the 5: 1 ratio sealing mixture an excellent alternative to sanding sealer for nose blocks etc and it works on foam. True - Value and Ace hardware stores carry Weld bond.

Finally there is Canopy Glue which used to be known as Wilhold RC 56. The Material Safety Data sheet defines it as Vinyl acetate polymer emulsions in water. Pacer calls it FORMULA 560. JZ Products, calls it Super Z RC 56 GLUE. It offers exceptional bonding of most all plastic and vinyl. It dries clear making it the glue of choice to use for attaching airplane canopies and vacuum formed ABS parts. When using it to attach a canopy or wind screen, trim the parts to as close a fit as possible. The glue will migrate under small cracks forming a complete seal and a very tight bond, the smaller the gaps the better the bond. You will need to clamp or tape the parts together for several hours until the glue starts to turn clear, full strength takes about 24 hours. Temperature and humidity will effect the drying times. If you coat both sides of the joint and let them dry for 5 to 10 minutes until it starts to turn clear, it will act as a contact cement. Press the coated surfaces together and they will grab eliminating the need to clamp for hours. It will still take time for the bond to gain full strength. It turns out that RC-56 type glues are also thermo-setting. A MonoCoat iron will activate a dried glue line if you wait too long to get them to grab. Just make sure you are below the melting point of the plastic being used.

## Unequal Cross Section Motor Length

*Stew Meyers*

Rubber motors are made up of loops of rubber, the number of strands therefore, is always even. The sizes currently available from FAI are 1/16, 3/32, 1/8, and 3/16. 1/4 has been discontinued. Braiding a motor is simplified if an even number of loops are used. There is a discrete jump in cross section as we add loops. Some times the desired cross section lies between these values. Of course you can haul out your \$200 Rubber Stripper and custom cut a rubber width. There is another approach however, use a motor made up of different widths.

Sometimes it appears that a little more torque would help. Perhaps the model has gotten heavier or there is no lift in the air. Since torque is a direct function of cross section, we need a little more. Usually an additional loop of the same size rubber would just be too much. The solution is to add a "helper Loop" or as Pat Daily calls it a "supercharger loop" of a smaller cross section. The question arises how long should it be?

To be efficient you would like to be loading up all the loops the same extent on their torque/turns curve. Lets look at a specific case. On my NIT embryo, two loops of 3/32 just isn't enough and two loops of 1/8 results in a shorter rocket like climb that is not efficient. A loop of 1/8 and a loop of 3/32 would appear to be ideal. Obviously, the same number of turns will go into each loop. Their torques will be additive.

The safe number of turns you can put into a motor is proportional to the length and inversely proportional to the square root of the total cross section area.

ie: width times number of strands, assuming a constant thickness.

$$T \propto L / \sqrt{W * N}$$

Set the number of turns for each loop equal to each other and the proportionality constants cancel out. Then solve for the length of a second loop.

$$L2 = L1 * \sqrt{W2 * N2 / W1 * N1}$$

For our case 1 is the 1/8 loop and 2 is the 3/32 loop. Since N1 = N2 = 2 these cancel out.

$$L2 = L1 * \sqrt{W2 / W1}$$

$$W2=3/32 \text{ and } W1= 1/8 \quad W2/W1=3/4 \text{ or } 0.75$$

The square root of 0.75 is 0.866. If the 1/8 loop is 20 inches long the 3/32 loop should be 20\*0.866 or 17 inches long. Not too much difference here, but if it was a 3/32 helper loop on a four strand 1/8 motor, the ratio is 3/8 and the factor becomes 0.61 and rather more significant.

Simply put, the length factor is the square root of the ratio of the total width of the loops. The larger the difference in total cross section of the loops the more pronounced the length difference. If you braid, each loop should have the same number of braiding turns.

## WAWAYONDA- The Rowsome Report.

You guys made a mistake in not showing; we had a lot of good flying. Only Glenn and I showed up from the home team, but Tom & John had 35 registered FAC contenders with better judgment. We had ideal conditions on Saturday up until noon: no wind of any consequence and pleasantly cool temperatures.

WW I was the first mass launch and in perfect conditions. Dave Mitchell had threatened to break my thumbs if I ever flew my enlarged dimer in WW I again without a 3-D engine, so I had modified it. Just as he hoped, it screwed up the trim so that it is no longer the world beater it once was. Properly jinxed, I dorked in the second round.

We had some excitement at 11:00 AM when one of the FAI contestants came up to report that they had lost one of their fellows in the corn, and he was long overdue. He had gone in with a Walston retrieval system to find his ship and never came out. One of his buddies found his airplane, and another found his cell phone in his car. He had had circulatory problems in the past, and they were afraid that he might have collapsed in the corn. Tom put the FAC contest on hold and about 20 of us spent an hour sweeping the corn looking for the missing modeler. The FAI contingent also called the cops, and about ten of them showed up too. At the end of the hour, the missing flier turned up at his car. He was fine. He had followed a signal from his Walston -- perhaps following his model as another brought it back -- on a long, long path through the corn. None of the FAI guys thanked us for our efforts, and we noted that few of their number participated in the search. Most of them kept flying. We had a job verifying we had all our own searchers back out of the corn.

New rule for Barron Field: you don't go into the corn without a working, turned-on cell phone and/or a buddy.

At noon, the weather gods flipped a switch: the winds suddenly reached a turbulent 12 MPH or so and held that until late afternoon. That was still flyable for ships already in good trim, with an ample window of stability, and the ability to grab altitude with dispatch.

We held Combined Racers in that weather. Three of us went in the corn in the first round, though my Chambermaid was not very deep in. Someone stumbled upon my racer (while looking for his own ship) by the time I completed one sweep. The other two were not so lucky. Neither made it back for the subsequent round (in deference to the conditions, the CD held it to two rounds). I won the final decisively with a 140 second flight, not bad for the conditions, but it put the Chambermaid very deep in the corn. This time I knew better than to trust to instinct and eyeball. I went for my

new, expensive binoculars with built-in compass. I got the bearing of the line with an accuracy of half a degree, and plotted a precise entry point in the corn. Ever helpful Ronny and Octavian of the Harfang Squadron helped with the search. Once in the corn, I verified my compass heading about every three or four rows of corn. The corn was about 8 feet high and very dry, so the leaves crackled and hissed as you walked through it, unable to see more than three or four rows away. To my surprise, I walked right to the Chambermaid, which was dead ahead of me! That, of course, was freak luck, but the compass and the method sure helped get in the neighborhood.

Vance was there, and he reported that he had a gig that night in New Jersey in a town just 40 minutes away. I tried to interest others in joining me, but I was the only flier to go to Vance's concert. As always, he was terrific.

On Sunday it was colder. The wind came up earlier than it had on Saturday and proved to be a nuisance -- but not prohibitive. This time the wind was mostly from the West, so the corn was not a factor. Twenty fliers showed up for WW II. The CD's decided to use two heats to winnow the crowd. Among the contestants was Maria Kondrat (I'm guessing at the spelling) with handsome fighter an Ambrosini 207-- her father swears she built herself with very little help. That may be true, as it looks better than any of her father's ships and better than most of those contesting the War. She is about 13 or 14 years old, and from Ontario. You may remember her from Geneseo. Her plane actually managed to be last down in the first round in her cohort! We were all very proud of her. To our utter astonishment and delight, she won the final and took the Kanone -- her first. She beat at least three Air Marshalls doing it too. Hers was a superb flight.

It turned out that Wally and Tom Hallman were tied in the race for Grand Champion going into the Flying Horde, but Wally won that (wouldn't you know) and so broke the tie.

### Photos Page 19

1. Maria Kondrat with her WWII winning Ambrosini 207. -Simpers photo.
2. Greg West with a P-39. -Simpers photo.
3. Bruce Foster with a Karkhov -10. -Gosselin photo.
4. Tom's Hallman and Nallen II launch their Goodyear racers. -Simpers photo.
5. Doug Beardsworth tests his Dh 103 Hornet. I think he's making motor noises. -Simpers photo.
6. The Mob scene at WaWa 2013 -Hallman photo.
7. Tom Nallen II's Dorand AR-1 Climbs nicely in a clear sky to net a 3<sup>rd</sup> in WWI. -Hallman photo

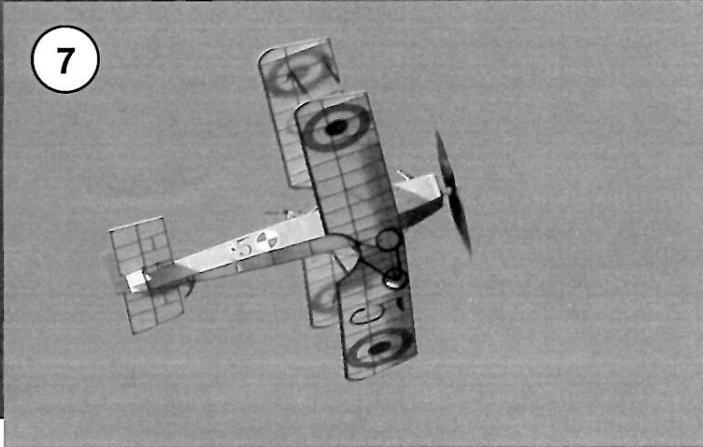

**MaxFax 2013-5  
(SEP-OCT 2013)**



D. C. MAXCUTERS  
% STEW MEYERS  
8304 WHITMAN DR.  
BETHESDA, MD 20817

PRSR STD  
US POSTAGE  
PAID  
PERMIT 6388  
SUBURBAN MD

**CONTENTS:**

**KING HARRY and PRINCE HAL  
White Glues  
Unequal rubber loops  
WaWa report  
NBM flyer**



2\*3\*\*\*\*\*ALL FOR ADC 210  
201402  
Mike Escalante  
212 Division Ave  
Hagerstown MD 21740-5040

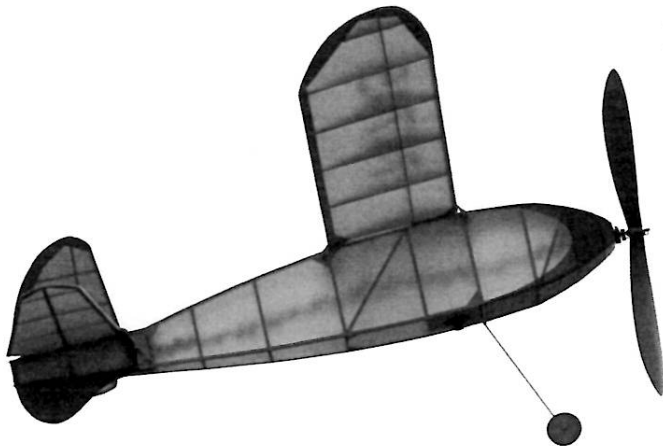

**OR CURRENT RESIDENT**

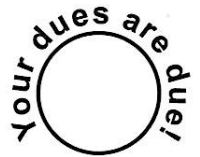

**You can now renew on line!  
Go to MaxFax on the website  
[www.dcmexcuter.org](http://www.dcmexcuter.org)**

*Pat Daily photos*

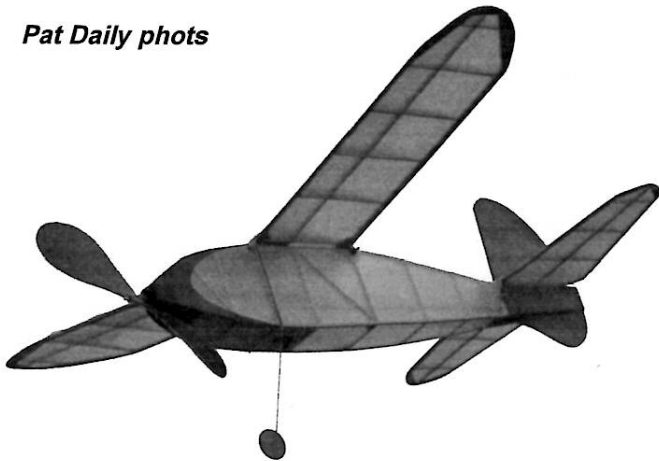

**A WIDE VARIETY OF MODIFIED POLY VYNAL ACETATE  
GLUES ARE USEFUL FOR DIFFERENT APPLICATIONS.**

A SYRINGE WITH A 1/32 ID TIP WORKS NICELY  
TO DISPENSE FULL STRENGTH TITEBOND II.  
(WHITE GLUE DOES NOT ATTACK THE RUBBER  
PLUNGER LIKE SOLVENT BASED GLUES DO.)  
A T-PIN PROVES TO BE A CONVENIENT STOPPER.

A RED (24 GAUGE) TEFLON TIP FROM  
MERCURY ADHESIVES FITS NICELY ON A SUPER  
'PHATIC BOTTLE.

A COMMON PIN ABOUT 0.020 OD SERVES AS A  
STOPPER.



**"KING HARRY"**  
DESIGNED BY  
K. EDGERTON.

SCALE: FULL SIZE.

CEMENT 1/16" DIA. BAMBOO THRO' FUSELAGE  
TO HOLD RUBBER BAND SECURING  
NOSE BLOCK.

POWER: 4 STRANDS 3/16" x 1/20" - 20" LONG  
OR 6 STRANDS FOR FASTER CLIMB.  
WEIGHT: 1.75 OZS. AVERAGE DURATION 70 SECS.

PICK UP 10 DIA CARVE FROM  
HARD Balsa 10 x 1 1/4 x 1/4  
10 S.W. 2 SHAFT WITH FREE WHEEL

From Aug '45 Aeromodeller

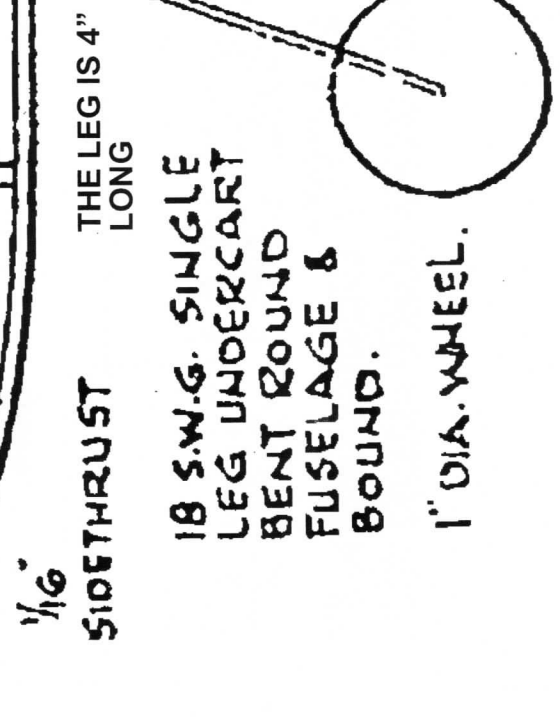
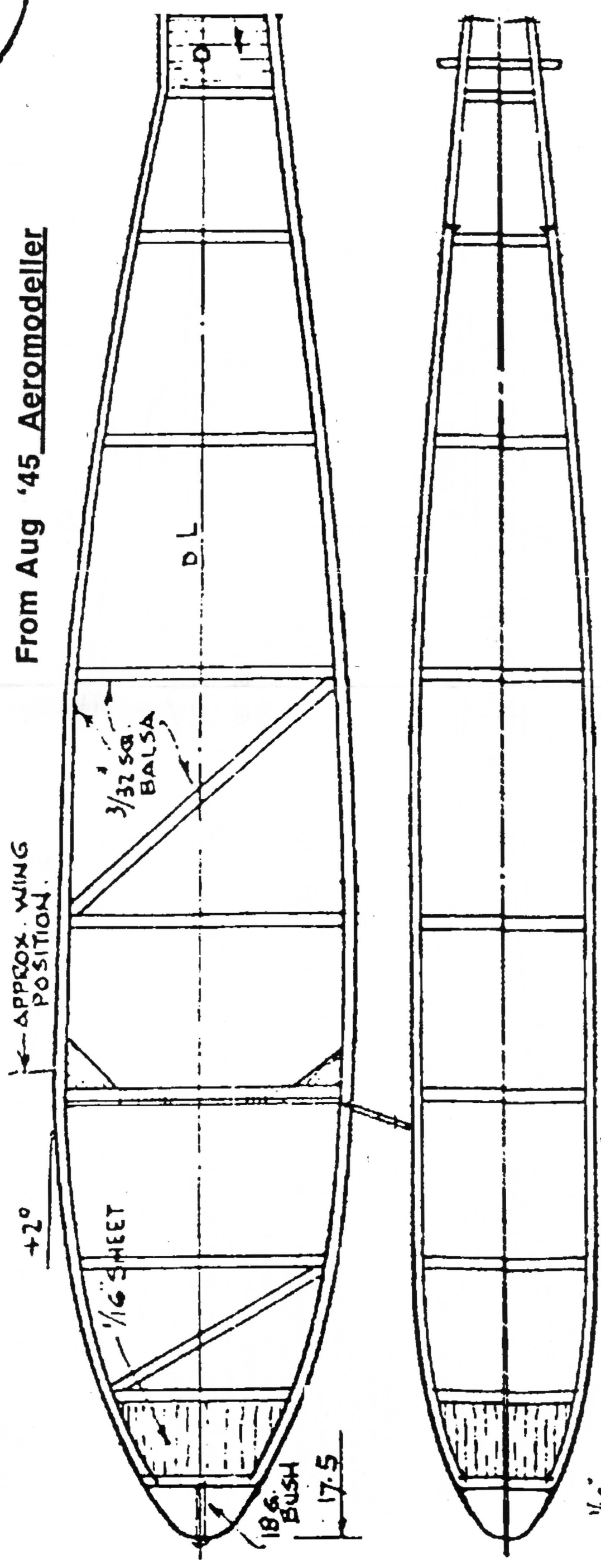
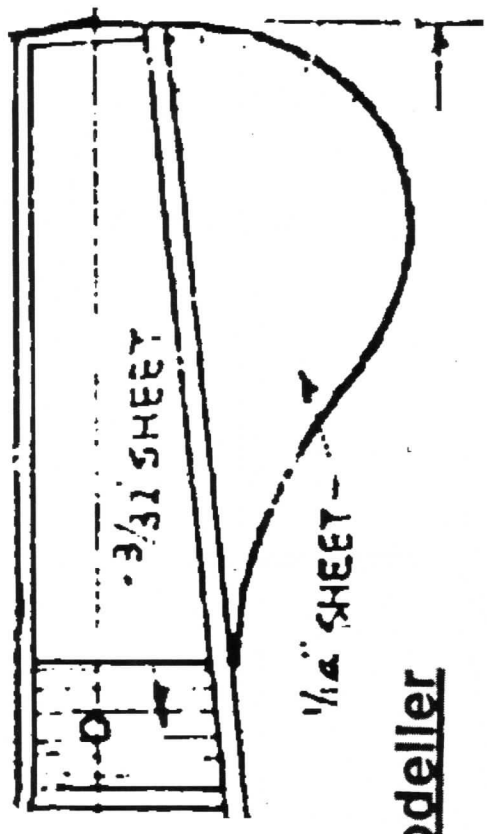

TO BE FAC LEAGLE YOU NEED TO BUILD KING HARRY NOT THE UPSATRT PRINCE HAL. I HAVE ENLARGED THE FUSELAGE DRAWINGS TO FULL SCALE SO YOU CAN BUILD IT EASILY. I HAVE REMOVED THE OFFSET NUMBERS SINCE THEY WERE FOR THE MOST PART INCORRECT. TAKE YOUR CROSS MEMBER SIZES DIRECTLY FROM THE TOP VIEW PRESENTED ABOVE. AFT OF THE RUBBER PEG THE FUSELAGE TAPERS LINEARLY TO THE TAIL POST. NO CROSS FORMER WERE SHOWN., BUT I WOULD ADD ONE AS WELL AS THE UPRIGHT LIKE PRINCE HAL HAS. YOU MIGHT WANT TO MOISTEN THE SIDES AT THE NOSE WHEN YOU PULL THEM IN. YOU CAN BUILD THE FIN AND STAB DIRECTLY FROM THE THE PRICE HAL PLAN SINCE THEY ARE IDENTICAL. JUST MAKE SURE YOU USE THE KING HARRY SUBFIN SHOWN ABOVE. YOU ALSO NEED TO USE THE SHORT WING. THE RIBS, SPAR, LE, TE, RIB SPACING ARE IDENTICAL AND THE ONLY DIFFERENCE IS THE WIDTH OF THE CENTER SECTION AND PLACEMENT OF THE WING TIP WHICH RESULTS IN A SHORTER WING SPAN. DETAILS ARE SHOWN ON THE WING PAGE.

# PRINCE HAL SON OF KING HARRY ORIGINAL DESIGN BY K. EDGERTON. PUBLISHED AUGUST 1945

WHEN YOU USE THIS DRAWING TO BUILD A STAB FOR KING HARRY, USE A 1/8 INCH SQUARE LEADING EDGE AND SPAR. THE TE IS 1/16 X 1/8 AND THE TIPS ARE 1/16TH SHEET.

I WOULD BUILD THE STAB FIRST BEFORE CUTTING OUT THE TAIL END OF THE KING HARRY FUSELAGE SIDE ON THE OTHER SIDE OF THE PLAN TO SPLICE TO THE FORWARD END.

## RUBBER MOTOR SIZING CONTINUED FROM P5

Center of Gravity. The plane must balance at a trim CG in order to fly properly. Motor weight and length affect CG. Motor CG will be at its midpoint. On a plane with a movable wing, the wing can be adjusted to accommodate different weights and lengths of motor. With a fixed wing, you may have no choice. Weight of motor will determine length or length will determine weight. It may be necessary to add ballast weight to accommodate the motor chosen. Ballast weight will increase the sinking speed. At some point, the added energy from a heavier motor will not overcome the added sink speed.

Structural Strength. The torque and tension in the rubber motor at full winds must be supported by the fuselage and appurtenant structures. A too strong motor will require strengthening the structures with corresponding weight increases. A weak structure will limit the size of the motor. Most of our model structures are pretty strong. This becomes an issue with ultralight indoor models.

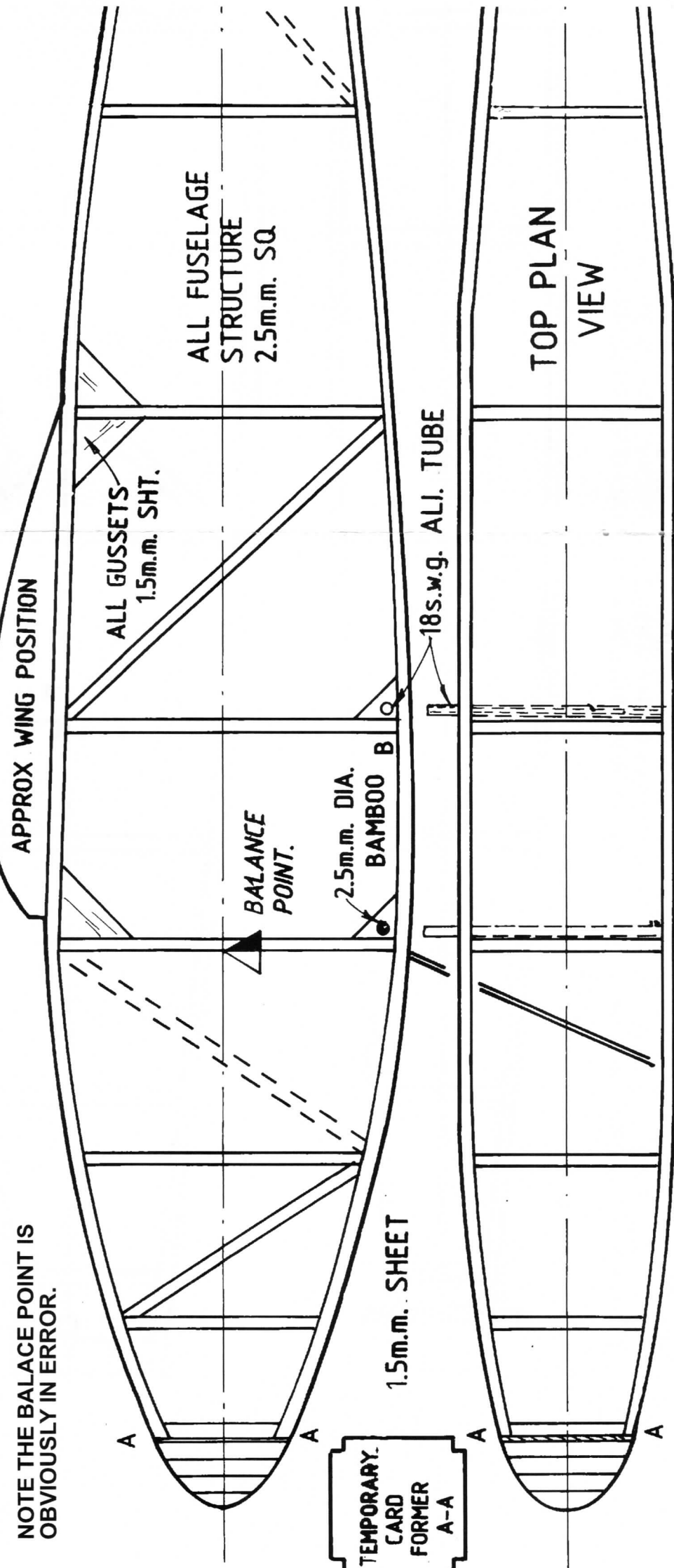
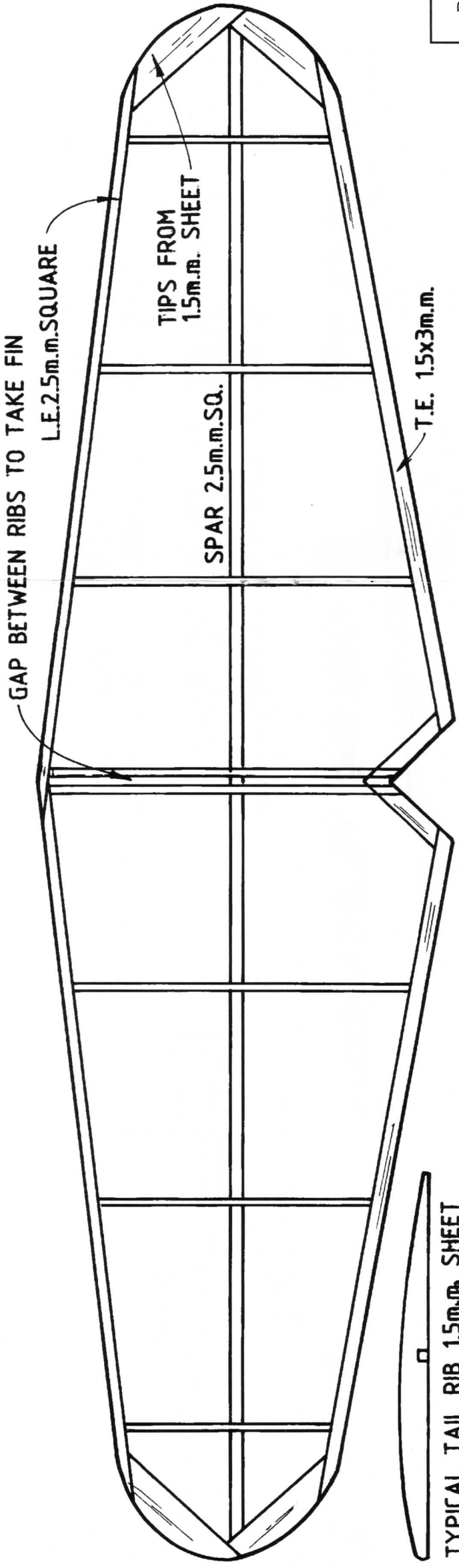

NOTE THE BALANCE POINT IS OBVIOUSLY IN ERROR.

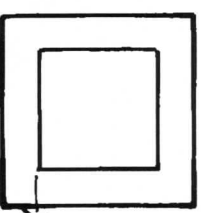
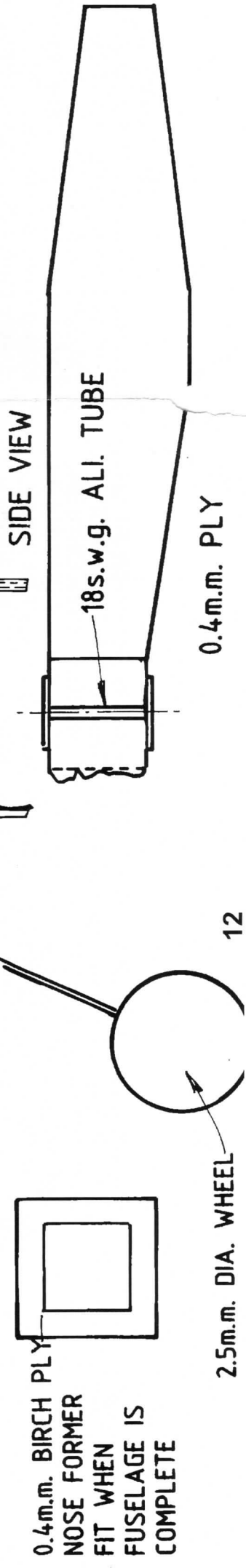



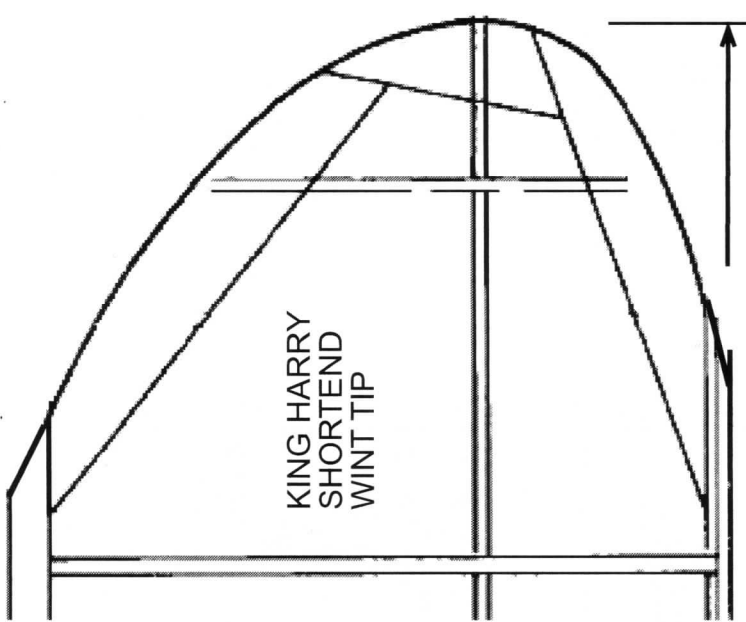
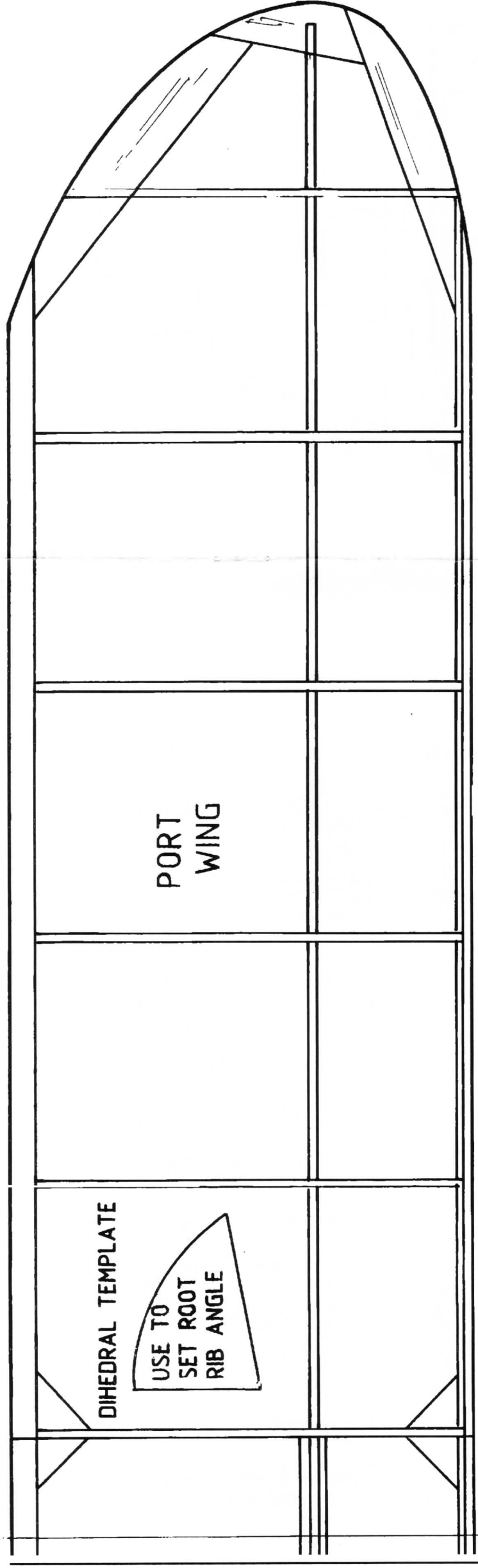

KING HARRY CENTER LINE

KING HARRY TIP 11" FROM ROOT RIB OR 12" FROM CENTER LINE

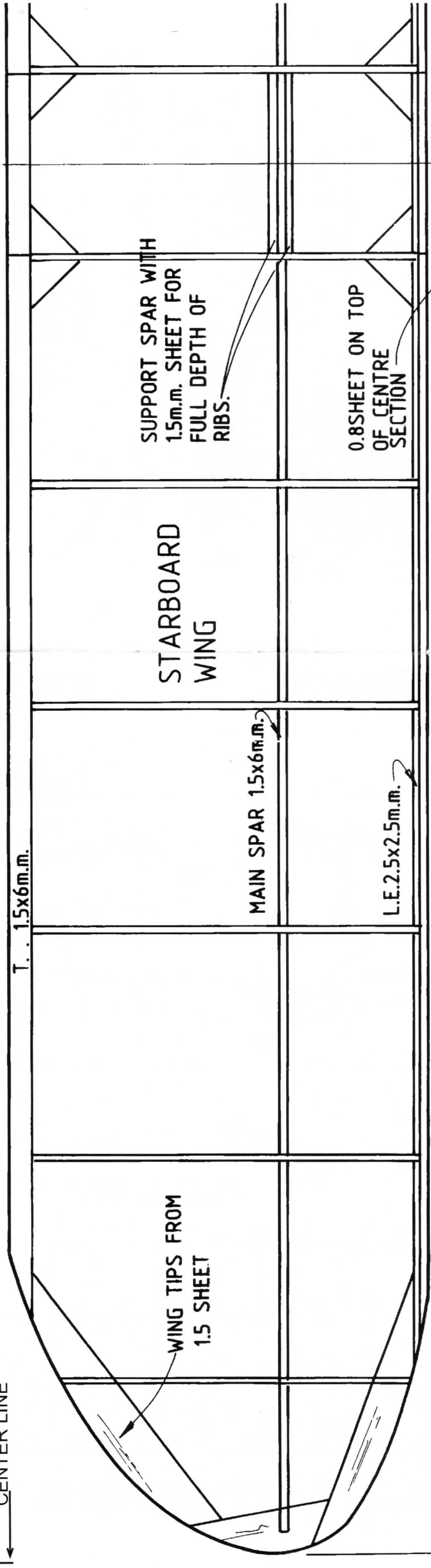

12 WING RIBS 1.5m.m. SHEET



50m.m. DIHEDRAL UNDER EACH TIP.

USING ANOTHER RIB AS A TEMPLATE

**PRINCE HAL SON OF KING HARRY ORIGINAL DESIGN BY K. EDGERTON. PUBLISHED AUGUST 1945**

THE PRINCE HAL AND KING HARRY RIBS, TIPS, SPAR, LE, & TE ARE IDENTICAL. JUST EXPAND THE CENTER SECTION TO 2" AND SLIDE THE TIP IN UNTIL IT MEASURS 11" FROM THE ROOT RIB. NOTE THE KING HARRY WING CENTER SECTION OVERLAPS THE 1-3/4" FUSELAGE WIDTH ACCORDING TO THE PLAN. WHILE THE LE 2.5MM SQ LE TRANSLATES TO 3/32 I USED 1/8 SQ. THE TE IS 3/32 X 1/4. THE SPAR IS 1/16 X 1/16 X 1/16 SHEET.