

# MAX FAX



## Journal of the D. C. Maxcuters

... home of the dreaded POTOMAC PURSUIT SQUADRON of the Flying Aces

Editor: Stew Meyers

2014-4



**D I M E   S C A L E   H E L L D I V E R   I S S U E**

## COMING ATTRACTIONS

**INDOOR FLYING HAS RESUEMED AT BAUER**  
**MON & WED 12:45 TO 2:15 PM**  
14625 Bauer Drive  
Rockville, Maryland 20853  
240-777-6922

**JANUARY 18 2015 NATIONAL BUILDING MUSEUM**  
**SEE FLYER IN THIS ISSUE**

**MARCH 8 2015 NATIONAL BUILDING MUSEUM**  
**SAME EVENTS AS IN JANUARY**

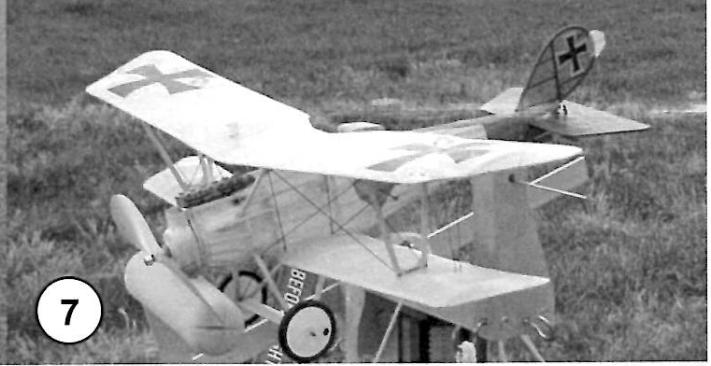
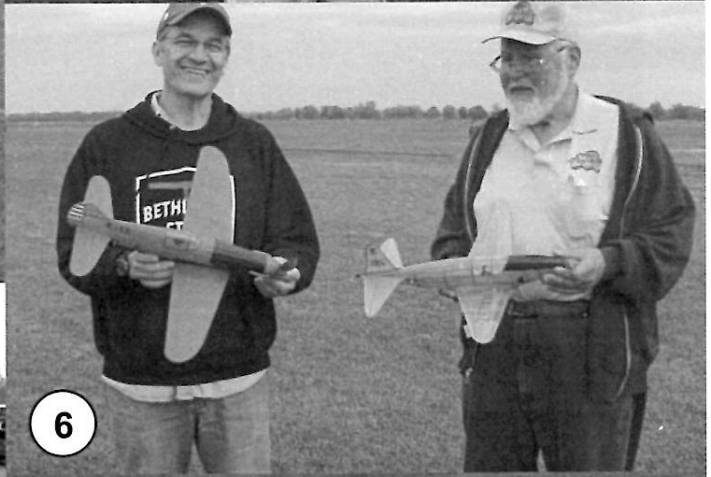

## MaxFax 2014- 4

NOTE - WE HAVE GONE FROM  
BIMONTHLY TO QUARTERLY

*Stew Meyers Editor*

### DIME SCALE HELLDIVER ISSUE

**Dave Mitchell has successfully rechartered the Maxcuters with the AMA. Of course they got he name wrong as" Maxcutters", but we will straighten that out.**

I know I just put out issue 2014-3 in November, but I need to put out this last issue now to catch up for this year. I am happy to say that going to four issues has substantially stanchied the flow of funds from the treasury and stabilized our budget. We are finishing the year in much better shape. That doesn't mean you shouldn't renew if you have X's in the renewal circle on the back cover.

Granted the last issue was an overdose of RTM, but bear with me as I put the finish touches on it in this issue regarding power out to the prop. I now plot run time, prop RPM and power. Dave Mitchell liked his profile SBC Helldiver which we published in the 2013 Nov-Dec issue so much that he has expanded it into a Neo-Dmer which we feature in this issue. Greg West blew this up to 20 inches and flew it in simplified scale at WaWa this fall. Neato, except for the wind! You may not know that Rick Pendzic has rewritten my NATS scoring program to make it more user friendly. He entered the WaWa 2014 data into it as a test. We present the results page here as the Barron Field Races. Glen Simppers, our Club president gives us the skinny on "Gurney" flaps. He also promotes flying at Piscataway and notes another indoor site for the winter. Ray Rakow has provided plans for an Ebenezer like profile Beech Staggerwing from an old SIG Air-Modler issue of March-April 1967. We have the results of the November Hurricane contest from NC.

### P2 PHOTOS from WaWa by Julie Farrell

1. Wally Farrell with his BN-1.
2. WWI winners with rewards given out by Bernie Dion.
3. Jack Kacian's beautiful Jumbo Waco got some flights in on Sat.
4. WWII fliers ready for the flight on Sunday.
5. Peter Kaiteris dressed for the weather on Sunday.
6. Tom Hallman and John Houck, Co CD's with their Fantasy ships on the warmer Saturday.
7. Octavian Aldea's nifty Pfaltz.

MEMBERSHIP - Dues for membership in the DC MAXECUTERS are **\$25** per year for residents of the USA, Canada, and Mexico, and **\$35** for all other countries. You may now use PayPal at the website:

**[www.dcmmaxecuter.org](http://www.dcmmaxecuter.org)**

Your mailing label indicates the year and month of the last issue of your current membership. A red "X" in the box below is a reminder that your dues are due. Send a check, payable to the "D.C. MAXECUTERS", to the treasurer, Stew Meyers.

**PUBLISHING DATES** - Four issues of MaxFax are sent each year, one each quarter, but since this is a volunteer publication nothing is guaranteed except that four issues will be sent to all members. ***(Rising costs and dwindling membership have forced us to go to four issues a year in 2014.)***

**CONTACTS** - Material for the newsletter and membership questions should be addressed to Stew Meyers phone 301-365-1749. Email gets immediate attention. [stew.meyers@verizon.net](mailto:stew.meyers@verizon.net)

### More in the developing RTM saga

I have implemented time recording of the turns count into the RTM (Recording Torque Meter) Arduino and computer terminal programs and added VB-6 code to the Excel spread sheet to compute rpm and power. No hardware mods were required.

The Arduino Microcomputer on the RTM gets triggered once per turn by the winder or by every other rotation of the prop. It then measures the torque, gets the time and puts out a stream of data to the P/C which gets stashed on an Excel spread sheet, which displays a real time Torque-Turns graph. Each row of the spreadsheet shows the number of turns, torque, and time for one measurement step. Since we now have the torque and turns data time stamped, it is easy to calculate the delta time for each step as well as the change in number of turns. RPM is simply the number of turns that occurred per step divided by the delta time for that step in minutes. To compute Power, the number of turns multiplied by two Pi and divided by time in seconds is multiplied by the torque for the step. Since our torque is expressed in in-oz the units are in-oz/sec. This is easy to convert to ft-lb/sec and then by multiplying by 1.356 to watts. (If you divide ft-lb/sec by 550 to get hp, the values get rally small. Milli-Hp seems a bit ridiculous.) I use watts to allow easy comparison to electric motors and a sanity check on the values I am getting.

In addition to the Torque vs. Turns Plot that is usually presented, we now can plot RPM & Power vs. Time for the unwind phase. (It makes no sense to plot this for the wind phase.) See the rear cover for an example. The area under the Power - Time curve is equal to the Energy Out derived from the Unwind - Torque curve. Plotting RPM vs. Power allows one to characterize the performance of the prop used, at least under static conditions.

## Barron Field Races 2014

Event#	Event Name	# Entries	Name	Plane	Place	Points
1	FAC Peanut Scale	5	THOMAS HALLMAN	Bleriot XXVI	1	25
1	FAC Peanut Scale		TOM 2 NALLEN II	Fokker M17 E	2	20
1	FAC Peanut Scale		Ed Pelatowski	Wittman Tailwind	3	15
1	FAC Peanut Scale		JOHN T. HOUCK	Miles M-18	4	10
1	FAC Peanut Scale		WALTER FARRELL	Floyd Bean	5	5
2	FAC Rubber Scale	6	THOMAS HALLMAN	DO-X	1	30
2	FAC Rubber Scale		PETER KAITERIS	ME 109Z	2	24
2	FAC Rubber Scale		Jack Kacian	Ercoupe	3	18
2	FAC Rubber Scale		BRUCE FOSTER	Chieftian	4	12
2	FAC Rubber Scale		GERALD KONDRAT	BF 109	5	6
3	FAC Jumbo Scale	4	THOMAS HALLMAN	MIG-Dis	1	20
3	FAC Jumbo Scale		WALTER FARRELL	BN1	2	16
3	FAC Jumbo Scale		Ed Pelatowski	Folkerts SK-3	3	12
3	FAC Jumbo Scale		Jack Kacian	WACO	4	8
3	FAC Jumbo Scale		BERNARD DION	Voyager	5	4
6	FAC Power Scale	3	WALTER FARRELL	Staggerwing	1	15
6	FAC Power Scale		VICTOR NIPPERT	WACO CG4	2	12
6	FAC Power Scale		THOMAS HALLMAN	DH-2	3	9
6	FAC Power Scale		Jack Kacian	XF 54	4	6
6	FAC Power Scale					
7	Low-Wing Military Trainer	3	David Mitchell	Magister	1	15
7	Low-Wing Military Trainer		WALTER FARRELL	Miles M.18	2	12
7	Low-Wing Military Trainer		TOM 2 NALLEN II	DHC-1 Chipmunk	3	9
7	Low-Wing Military Trainer					
8	Golden Age Combined	5	David Mitchell	Piper PA15	1	25
8	Golden Age Combined		Glen Simperts	Howard DGA-15	2	20
8	Golden Age Combined		MARK HOUCK	Piper Vagabond	3	15
8	Golden Age Combined		GERALD KONDRAT	Miles Hawk	4	10
8	Golden Age Combined		Richard Pendzick	SR-8	5	5
13	2-Bit +1 OTR Fuselage	4	OLIVER SAND	Jr Commercial	1	20
13	2-Bit +1 OTR Fuselage		JOHN STOTT	Skokie	2	16
13	2-Bit +1 OTR Fuselage		JOHN T. HOUCK	Skotch	3	12
13	2-Bit +1 OTR Fuselage		MARK HOUCK	JA Special	4	8
13	2-Bit +1 OTR Fuselage					
16	Simplified Scale	7	WALTER FARRELL	Cessna 140	1	35
16	Simplified Scale		David Mitchell	Stinson 049	2	28
16	Simplified Scale		Ed Pelatowski	P-47	3	21
16	Simplified Scale		ANDREW RICCI	Fokker D7	4	14
16	Simplified Scale		Greg West	SBC-3	5	7
17	Dime Scale	9	WALTER FARRELL	Staggerwing	1	45
17	Dime Scale		THOMAS HALLMAN	Staggerwing	2	36
17	Dime Scale		ANDREW RICCI	P-51B	3	27
17	Dime Scale		Octavian Aldea	Fockler D7	4	18
17	Dime Scale		OLIVER SAND	Rearwin Cloudster	5	9
18	No-Cal Profile	8	WALTER FARRELL	Cardinal	1	40
18	No-Cal Profile		James Hemmel	Martin Mauler	2	32
18	No-Cal Profile		JOHN T. HOUCK	Meteor	3	24
18	No-Cal Profile		Glen Simperts	P-40	4	16
18	No-Cal Profile		ED NOVAK	Farman 192	5	8
20	Embryo Endurance	14	CHARLIE SAUTER	Debut	1	70

## Barron Field Races 2014

20	Embryo Endurance		WALTER FARRELL	Debut	2	56
20	Embryo Endurance		PAUL STOTT	FAC Gypsy	3	42
20	Embryo Endurance		James Hemmel	Swallow	4	28
20	Embryo Endurance		OLIVER SAND	Big Cat	5	14
21	Jet Catapult	5	PETER KAITERIS	Arsenal VG90	1	25
21	Jet Catapult		Glen Simperts	Banshee	2	20
21	Jet Catapult		ED NOVAK	F-84	3	15
21	Jet Catapult		WALTER FARRELL	Air Cobra	4	10
21	Jet Catapult		ANDREW RICCI	Arsenal	5	5
22	Fiction Flyer	5	THOMAS HALLMAN	Smilin' Jack X-13	1	25
22	Fiction Flyer		JOHN T. HOUCK	Joy's Racer	2	20
22	Fiction Flyer		WALTER FARRELL	Booth Racer	3	15
22	Fiction Flyer		Greg West	Scarlet Stormer	4	10
22	Fiction Flyer		JACK BARKER	Mystery Tailless	5	5
25	Goodyear / Formula Race	5	RICHARD GORMAN	Sonerai	1	25
25	Goodyear / Formula Race		David Mitchell	Swee' Pea	2	20
25	Goodyear / Formula Race		THOMAS HALLMAN	Snookie	3	15
25	Goodyear / Formula Race		ANDREW RICCI	Mirage	4	10
25	Goodyear / Formula Race		WALTER FARRELL	Mirage	5	5
26	WWI Combat	8	THOMAS HALLMAN	Fokker	1	40
26	WWI Combat		WALTER FARRELL	MartinSyde	2	32
26	WWI Combat		RICHARD GORMAN	SE-5	3	24
26	WWI Combat		Stewart Meyers	ALB D-1	4	16
26	WWI Combat		BERNARD DION	Hanover CIII	5	8
27	WWII Combat	15	ANDREW RICCI	P-51	1	75
27	WWII Combat		WALTER FARRELL	P-51	2	60
27	WWII Combat		CHARLIE SAUTER	P-51	3	45
27	WWII Combat		BRUCE FOSTER	Karkov	4	30
27	WWII Combat		Jack Kacian	Typhoon	5	15
28	B.L.U.R.	3	ANDREW RICCI	Chambermaid	1	15
28	B.L.U.R.		PETER KAITERIS	JackRabbit	2	12
28	B.L.U.R.		ED NOVAK	Mr Smoothie	3	9
52	Thomson / Greve Combined	14	David Mitchell	Mr Smoothie	1	70
52	Thomson / Greve Combined		PAUL STOTT	Haines	2	56
52	Thomson / Greve Combined		James Hemmel	Brown B-2	3	42
52	Thomson / Greve Combined		Ed Pelatowski	Folkerts SK-2	4	28
52	Thomson / Greve Combined		RICHARD GORMAN	Cessna CR-3	5	14
55	NBM Flying Horde	12	Glen Simperts	Howard	1	60
55	NBM Flying Horde		Richard Pendzick	SR-8	2	48
55	NBM Flying Horde		CHARLIE SAUTER	P-51	3	36
55	NBM Flying Horde		Greg West	Scarlet Stormer	4	24
55	NBM Flying Horde		STEVE EVANS	P-51	5	12
59	Contra Rotating Prop ML	4	WALTER FARRELL	Koolhoven 55	1	20
59	Contra Rotating Prop ML		David Mitchell	Caproni	2	16
59	Contra Rotating Prop ML		THOMAS HALLMAN	Koolhoven	3	12
59	Contra Rotating Prop ML		ANDREW RICCI	Koolhoven	4	8
67	Flying Horde	7	WALTER FARRELL	Mr Smoothie	1	35
67	Flying Horde		Richard Pendzick	Sr-8	2	28
67	Flying Horde		BERNARD DION	NA	3	21
67	Flying Horde		CHARLIE SAUTER	P-51B	4	14
67	Flying Horde		Stewart Meyers	KR-5	5	7

## SBC-3 HELLDIVER NEO-DIMER

By Dave Mitchell

I designed this beastie after having some success with the pair of NoCal Helldivers presented in the MaxFax a couple of issues back. It was a pretty short hop from those plans to a 3-D SBC-3, something I had been aiming to do for some time as an alternative to Rich Weber's Beech Staggerwing (recently nicely kitted by Easy Built). THAT little sucker has been mopping up the Dime Scale contests for a few years now, and if the Helldiver is a bit more complicated in construction, I figure it's still got enough other things going for it to make it a contender worthy of your consideration.

Construction is relatively straightforward dime-scale stuff. I tried to keep it as simple as possible, while still conveying what Scot Dobberfuhl calls the "zaftig beauty" of the real thing. This did require a couple of stringers here and there, and running the lower wing in one piece requires that you stage your construction and covering a bit-cover the lower wing first, and the sides and top of the fuselage, then glue in the lower wing, before running the lower fuselage stringers and covering the bottom. All stab and wing tips, as well as the upper wing cockpit cut-away and the majority of the rudder outline, are built up from 1/16" x 3/16" strip and then sanded to the correct outer curve. And while I guess it's technically not in the spirit of Dime Scale, I also designed a folded paper jig to assist in aligning the cabane struts. You can ignore it is you want, but it made it a lot easier, I can promise you!

Color schemes are all over the place. I chose BuAer 0571 from the USS Saratoga, ca. 1938 'cause I liked the white tail, simple as that. The markings on my model are all inkjet on tissue, with a light spray coat of white on the backside to increase the opacity of the colors.

How does she fly? Pretty darn well. Like the NoCal versions, mine flies right and sometimes struggles a little with a torque roll to the left just after launch. I haven't worked that out just yet, but once past that part she climbs out with the best of 'em. Mine came out at 18g w/o rubber; so far I've had pretty good success flying her on 4 strands of 3/32" x 32", well braided, with a nice carved 7" paulownia prop on it, p/d about 1.4.

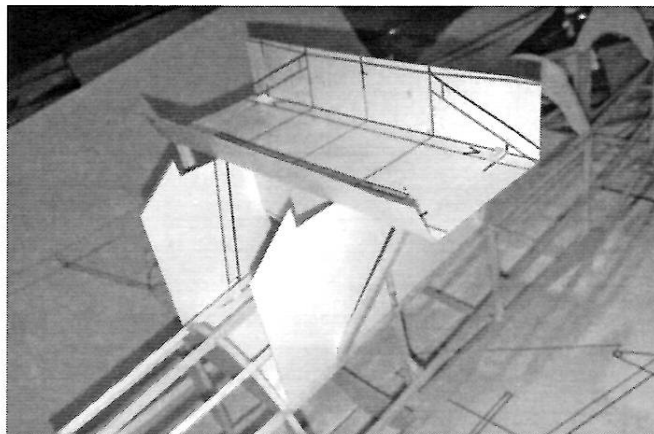
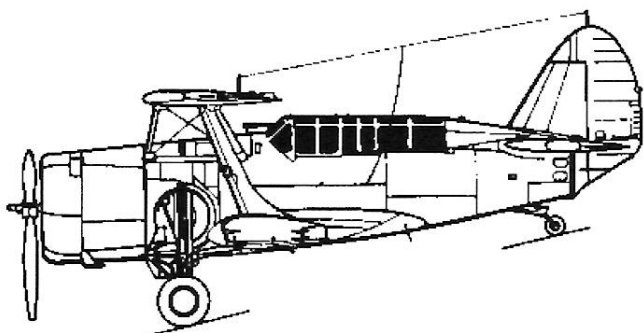

#1 The cabane strut alignment jig shown here is slightly different than the final version provided, but works the same way. To make the jig, print out full size on some fairly stiff paper and cut out carefully. On part #1 pre-bend the main folds indicated by the dashed lines. Cut away the slot that runs across from the shaded areas "A" and "B", as well as the four black slots at the fold lines. You also have to make the cut marked by the dotted line at the bottom of the slot, right next to the shaded area marked "B". AFTER you have run the stringers for the top of the fuselage nose, the jig is slipped flat across the top of the longerons, between the first and third formers, with the slot you cut away straddling the second former; the dotted line cut is then taped closed, and the sides folded up 90 degrees. Once the folded jig is fitted into place on the fuselage and lightly tacked into place with glue-stick, glue-stick part #2 and part #3 into position. The over-long cabane struts are then slid through the cut outs in the top plate of the jig, and their lower ends are beveled, fitted and glued into position on the fuselage longerons at the locations provided. Once dry, the struts are cut flush to the top plate (slightly proud if you are going to fit them into pockets in the wing ribs) and the jig is carefully cut out and discarded.

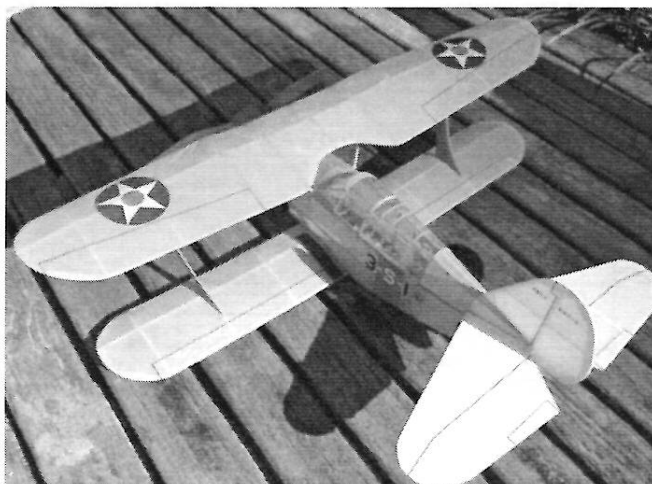

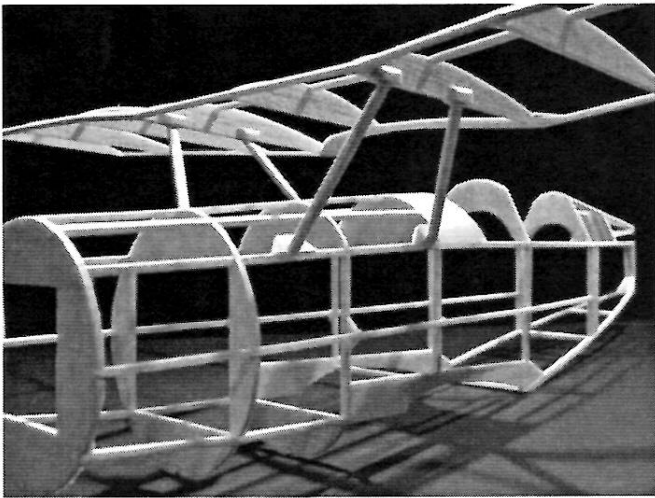

#2 Close up of the cabane strut assembly. Note the fill balsa around the strut bases at the longerons, to provide a tissue attachment point. The fuselage is covered after the struts are attached. Also note the cabane struts are fitted into pockets in the upper wing ribs.

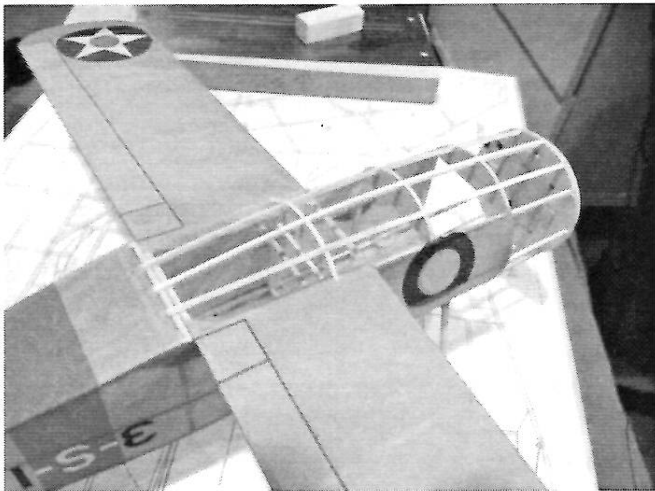

#3 The lower fuselage stringers are run after the fuselage top and sides have been covered and the covered lower wing is glued into place. Note that the last rounded former is glued to the lower wing. The tail ends of the stringers run over the TE of the lower wing and tie into the cross-member.

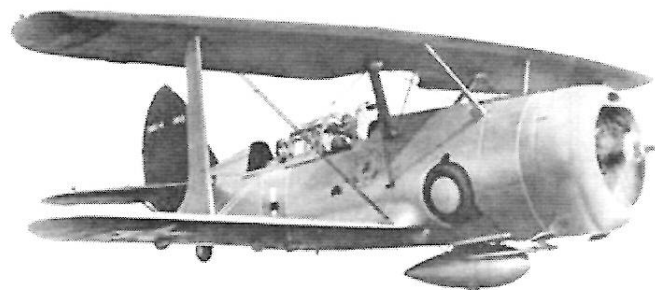

Let me promote a change in the Simplified Scale Rules to drop the 16" lower limit. All neo dimers should be flown as Simplified Scale! If someone wanted to modify an original dimer beyond the changes spelled out in the rules, it could be flown in Simplified scale. (Laminating wing tips or tails comes to mind.) Real old timer dimers shouldn't have to compete with Neo's. To claim to be original the flyer needs only to submit a plan as proof. The CD only needs the balls to toss a questionable design into Simplified Scale, not the end of the world.



Greg West's 20" SBC version of the Dimer

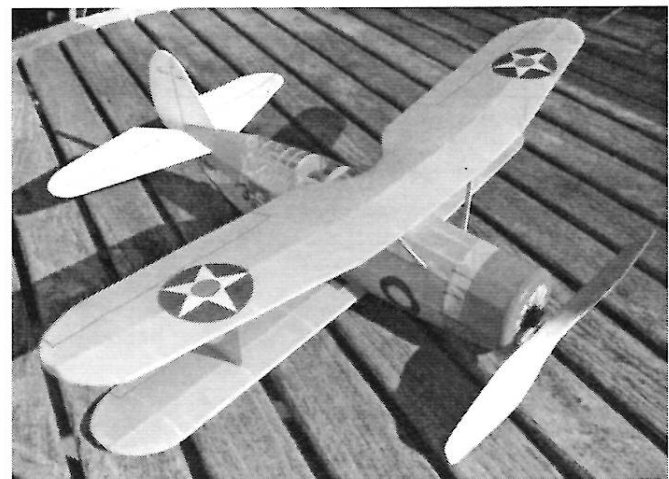

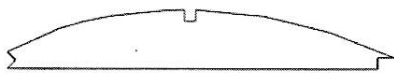
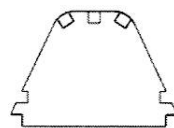
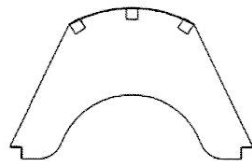
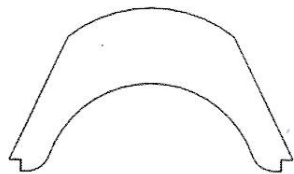
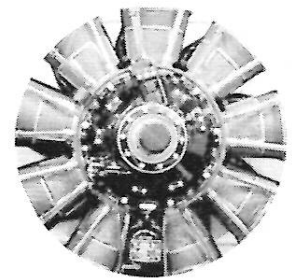
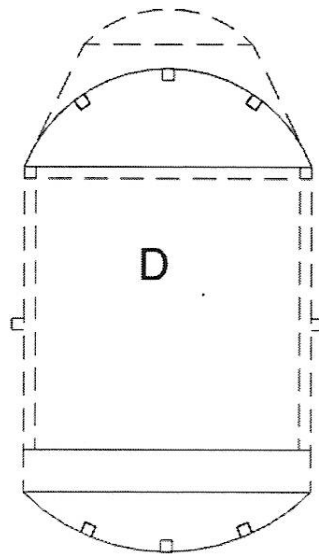
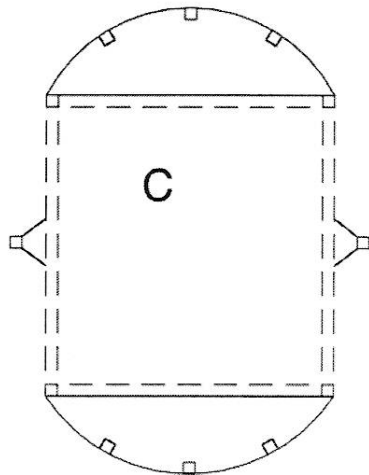
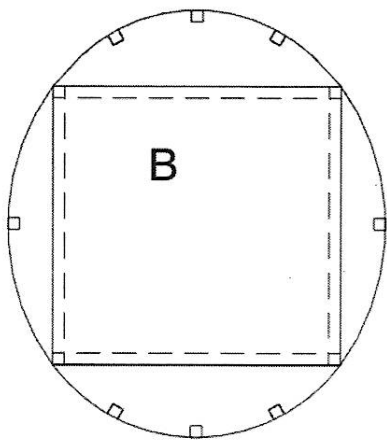
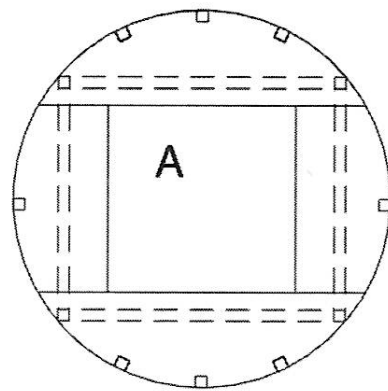
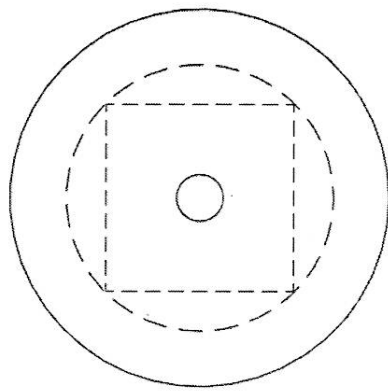
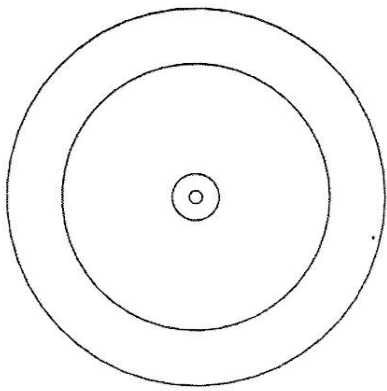

X1

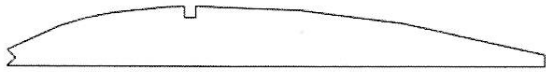

X4

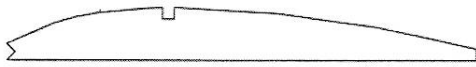

X2

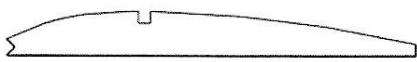

X2

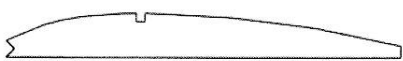

X8

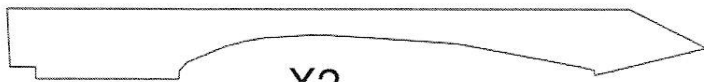

X2



X2--trim top to length



# paper jig templates--Curtiss SBC-3 Helldiver

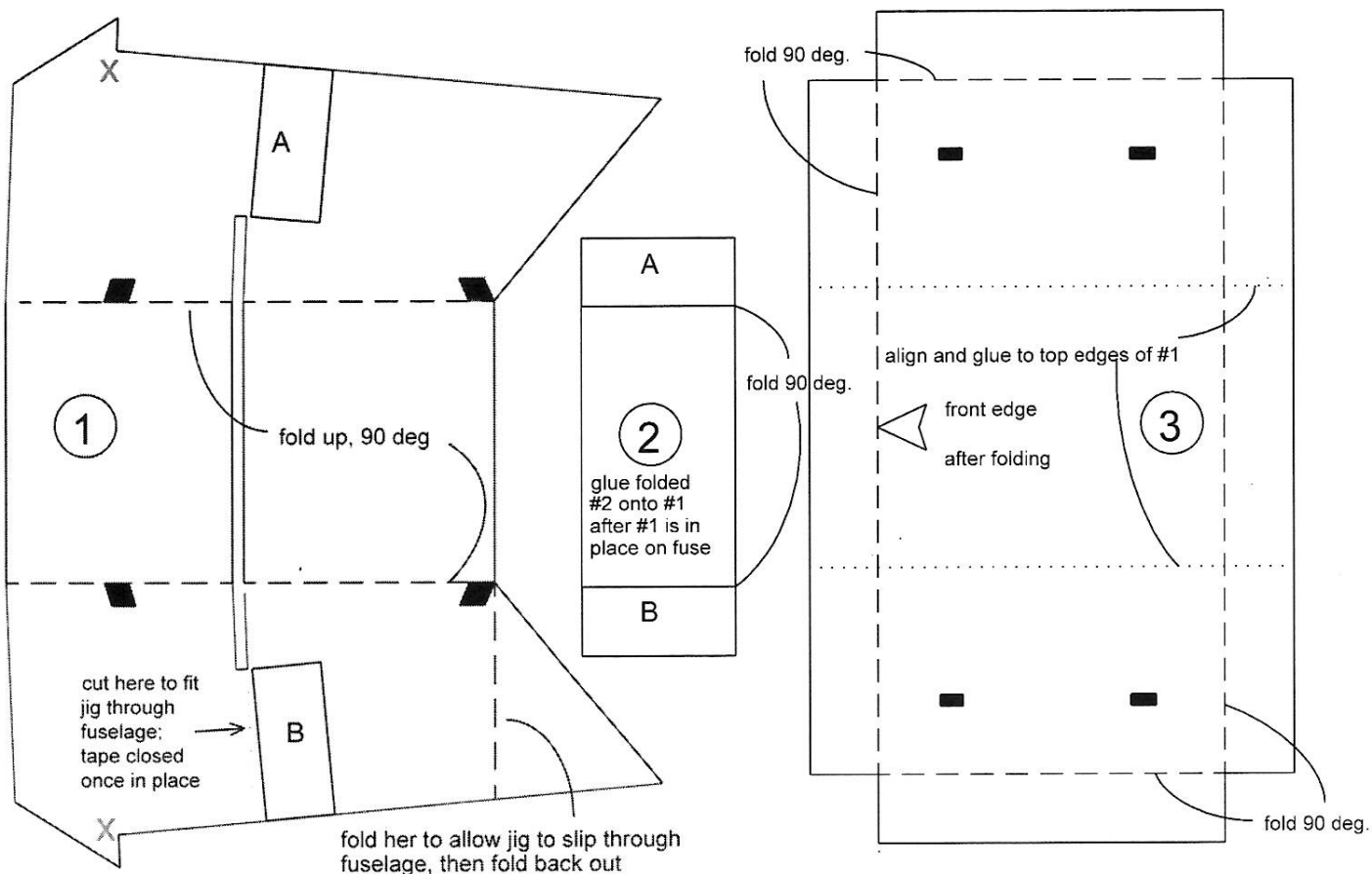

## Wally's comments on the Fall Kudzu...

The Hurricane Challenge was lightly attended this year, but we still had a great time flying. Saturday was chilly in the morning, and I scraped the frost off the windshield as we left the motel. When we arrived, the CD's, John Diebolt and Jimmy Jordan were there and we started setting up in the middle of the field. The first thing that happened was that they passed out glue and LED flashlights as a "thank you for showing up" gift to all the flyers, a really nice thoughtful gesture to get the day started. Although cool, it was sunny and the first thing I did was to start trimming my "new" jet cat. I had re-purposed the wing off my old Lightning and cut out the center section and put in ribs and covered it with tissue- thanks to Pete Kateris and Vic Nippert for this idea. It worked great. The glider needed some "up" so I put gurney flaps on the stab and started shooting. I was amazed to see it actually glide well and it did about 50 second officials twice, backed up by about a 30. I was really happy to see it go. Then the clouds rolled in and did not leave. I had the pleasure of seeing Gary Morton again, who made a huge trip from Tennessee to get to the meet. He has a 10" Canberra jet cat that was simply amazing. His jets were beautifully crafted and flew well. I also got to meet a new flier, Dave Beazley who lives about 40 or so minutes east of me. He is an RC flier who has recently started flying Free Flight and looks like he will be a great addition to the ranks. AMA columnist Louis Joyner was there flying a high tech Wakefield, boy was it a sight to see, it flew great. The AMA glider events were lead by who else but FF legend Kit Bays. About 3:00 or so I tried to fly my tow line glider with the help of Julie and then Frank Rowsome...the conditions at this point were windless and I could not run fast enough to get it off the hook, could not post an official! Yikes!

WWII had 4 participants: Frank Rowsome, Dave Franks, Jimmy's grandson Matthew and me. Frank and I flew the last heat with my Mustang just squeaking past Frank's F4F. Whew. I entered several events and got to fly P-30, and all of the FAC events. My no-cal Cardinal did OK, but never threatened to leave the field-we cajoled good ol' Abram Van Dover into flying his no-cal to get 3 participants...The Brainbusters were well represented by him, Jim Kelly and Bob Bennet. Although cloudy, there was some lift in the mid afternoon and Jimmy J lost his P-30, I believe the only lost ship during the weekend.

Sunday was not as cool but the air was heavy, again the clouds just would not leave. I had one max with a scale plane all day. We were parked near the trees and lift was just plain in short supply. The air made the planes look as sluggish as my ex-brother-in-law. Highlights including a tutorial in how to fly race planes by Frank Rowsome. He got that Chambermaid way up, and I swear you could hear the prop buzz as it climbed. Jimmy J and Matthew flew the heck out of their Phantom Flashes and although I maxed once, I could not catch them. Matthew is growing into a great flier and competitor, it was great to share the field with him.

There was an unusual target time event at the meet. The target time was 43 sec, you could use any one plane you wanted. If you had a d/t, the clock stopped if the d/t tripped. This was the most popular event! I flew my recently repaired Mig 15 and came close. I think Bob Bennett won.

## National Building Museum – 1/18/2015

BUILDING OF DELTA DARTS (8:30 – 11:00)

FREE FLIGHT ATRIUM EVENTS:  
FLYING EXPOSITION (11:00 – 4:00)

### Mass Launch Events:

- 12:00 **Bostonian** -14g. Minimum Weight without rubber  
– ROG
- 12:45 **Parlor Fly** - Plans on Maxecuter web site
- 1:30 **WW-II No-Cal** - 6 g. minimum weight without rubber
- 2:15 **Dime Scale** - FAC Rules
- 3:00 **Phantom Flash** - FAC rules – plastic prop – ROG
- 3:45 **Zaic Z-15** (a simple tissue covered model)  
- plans on website

### Timed Events:

to be flown throughout the day 11:00 to 4:00):

**Peanut Scale** (Judged at the Head Table) - FAC rules

**Limited Pennyplane** - We are using the AMA rules.

#### Pennyplane

(3.1 g. min. w/o rubber, not more than 20 in.  
long, projected wingspan no more than 18 in.; 10  
in. max. motor stick, direct drive rubber motor )  
further limited by a wing chord no more than 5  
in.; horiz. stab no more than 4 in. by 12 in. Motor  
stick must be solid; prop. dia. limited to 12 in.; no  
gadgets (variable pitch prop mechanisms, etc.);  
wing must be monoplane.

**A-6** - sample plans and rules on web site.

**No-Cal** - 6 g. minimum weight without rubber

### NBM NOTES:

- Airplanes that have won twice before at the National Building Museum cannot further compete and must be retired to exhibition and fun flying only.
- Certificates will be awarded to those who have exceeded one minute in flight or have risen above the 4th floor catwalk and safely returned to the floor.
- Youth fliers should check in at the head table to be instructed in the flying protocol for indoor flying (clear the floor after launching; no running; don't pick up another's model).
- Grand Champion calculation: The points awarded to a flyer will equal the number of flyers that finish behind the winner in any given event.
- Note that some of the events have minimum weight limits, so please prepare your models accordingly.

Send Glen Simperts a note before 1/14/15 if you desire entry to the museum before 11:00. Your note should include all names in your party and have names as they appear on your driver's license.

Glen Simperts, grfreeflight@hotmail.com,  
301-843-2896

RC ATRIUM EVENTS:  
FLYING EXPOSITION (11:00 – 4:00)

1. **Tortoise and Hare Event** for the slowest flying model to complete a figure eight.
2. **Mini Vapor Combat.**
3. **Mini Vapor Race**
4. Most Unique/Creative RC model to complete a figure eight.
5. Most Beautifully Crafted Non-ARF Foam Model to complete a figure eight.
6. Most Beautifully Crafted Non-ARF Balsa-Tissue Model to complete a figure eight.

Free style flying between events.

### SKYSTERS...

The D.C. Maxecuters are flying in the Great Hall of the National Building Museum on 1/18/15. What a great way to start off the new year! Flying light-weight rubber-powered and electric models inside an historic building is always fun. Listed below is an announcement about activities. The club will again be helping the NBM with a building project for kids early in the morning. Paul Stamison will again lead the RC atrium.

This year there is an additional challenge. There will be architecture installation in the building during this Winter's flying. The NBM will hang architectural models from the third balcony so that they will be a eye level just off the second floor balcony. The models will rest on a platform about three feet wide and 8-10 feet long with clear plastic sides (like a clear upside down box top). I understand that there will be large number of these hung just off all of the second floor balconies (all three atriums). While the RC guys can probably avoid getting trapped in the boxes, it will be a new challenge for the free flying models. We anticipate the installations will be a model magnet. The exhibit will have grand opening around the 23rd of January and the show runs through May. I expect they will already be installed when we fly on Jan. 18.

We will have the flying as planned with this year's limitation in mind. Please plan accordingly. I would like to solicit two people skilled in the use of steering poles to help us keep the lighter models away from the exhibits.

We will also be flying in the NBM on 3/8/15.

## CAFFA-KUDZU FALL CONTEST 11-8/9-14

WWII MASS LAUNCH			FIXED TIME TARGET 42 SECONDS		
WALLY FARRELL	MUSTANG	1	PHIL HARTMAN	42.97 SEC.	1
FRANK ROWSOME	F4F	2	BOB BENNETT	42 SEC.	2
DAVID FRANKS	P51 MUSTANG	3	JIM KELLY	45 SEC.	3

COMBINED RACERS MASS LAUNCH			PHANTOM FLASH		
FRANK ROWSOME	CHAMBERMAID	1	JIMMY JORDAN	312 SEC.	1
WALLY FARRELL	Mr. SMOOTHIE	2	WALLY FARRELL	296 SEC.	2
DAVE FRANKS	CHAMBERMAID	3	MATTHEW CANADY	259 SEC.	3

DIME SCALE			P-30 RUBBER		
WALLY FARRELL	BEECH STAGGERWING 267	1	WALLY FARRELL	334 SEC.	1
GARY MORTON	WATERMAN GOSLING 185	2	BOB BENNETT	299 SEC.	2
JOHN DIEBOLT	B.A.T. MONOPLANE 114	3	ED DULLENGHAM	168 SEC.	3

NO CAL			CLASSIC TOWLINE GLIDER		
WALLY FARRELL	CARDINAL 290 SEC.	1	KIT BAYS	265 SEC.	1
GARY MORTON	EXTRA 400 225 SEC.	2	PHIL HARTMAN	28 SEC	2
ABRAM VanDOVER	FARMAN 180 188 SEC.	3			

JET CATAPULT			AMA HAND HELD CATAPULT GLIDER		
WALLY FARRELL	P-39 171 SEC.	1	KIT BAYS	263 SEC	1
GARY MORTON	CANBERRA 121 SEC.	2	WALLY FARRELL	159 SEC	2
JOHN DIEBOLT	ARADO Ar 234 71 SEC.	3	LOUIS JOYNER	152 SEC.	3

SIMPLIFIED SCALE			TWIN PUSHER MASS LAUNCH		
WALLY FARRELL	VAGABOND 280 SEC.	1	BOB BENNETT		1
WALLY FARRELL	CESSNA 140 SEC.		JIM KELLY		2
			JOHN DIEBOLT	DNF	

EMBRYO			E-20 ELECTRIC		
WALLY FARRELL	DEBUT 329 SEC.	1	GARY MORTON	155 SEC.	1
JIMMY JORDAN	NIT II 271 SEC	2			
GARY MORTON	PRAIRIE BIRD 224 SEC.	3			

TWO-BITS + 1			FIXED TIME TARGET 43 SECONDS		
WALLY FARRELL	BANTAM 225 SEC.	1	PHIL HARTMAN	42.97 SEC.	1
GARY MORTON	FAC MOTH 190 SEC.	2	BOB BENNETT	42 SEC	2
JIMMY JORDAN	FAC MOTH 179 SEC	3	JIM KELLY	45 SEC	3

### Kuzu report from Frank Rowsome

The weather was ideal for fall Kudzu meet: temperatures started chilly and rose into the sixties with dead calm to about 4 mph winds both Saturday and Sunday. There was little lift either day -- though a little here and there. As a result, nothing got lost, and nearly all the flight times were earned the hard way. The event list was heavy on endurance and light on scale events. That may have contributed to the poor turnout of rubber scale fliers. Only Wally Farrell, David Franks, and Frank Rowsome came from states to the North. Quite a few came from the sponsoring South Carolina club. Still, the superb flying weather delighted all who attended. Pretty obvious Wally was grand champ.

The oft-changing wind drift direction did give Wally some anxious moments. One of his ships flew low over and among the trees until an agonizingly slow turn in the flight path -- and in the wind drift direction -- gradually brought his ship back over the sod where it subsequently landed. Later Wally ran himself silly trying to get his tow line glider up on the line. It needed more airspeed than his run in the still air could provide. Otherwise, it was a weekend of fabulous flying.

# Gurney Flaps and Related Airfoil Mysteries

Glen Simperts

Airfoils are discussed when modelers are not actively building, flying, or making imaginary airplane sounds. Gurney flaps are one of these airfoil devices that consist of a small angle (.01- .02 chord) that dangles below the airfoil at the trailing edge of the wing. They are used to modify the airflow either to change wing lift overall or locally applied to adjust the trim of the airplane.

## What they are and they work?

R. Liebeck developed a sophisticated low speed two element airfoil for application to Indianapolis racing cars using computer modeling (ref.1). The LI 74 airfoil as designed had a very thin trailing edge. It vibrated at race speeds so the race car team reinforced the trailing edge with small angle iron. Both the lift and L/D improved. This was a surprise to the race team, but would not have been to modelers such as Bill Gieskieng who described a similar trailing edge wedge back in the 1964-65 Zaic Yearbook (ref. 2). The thing that surprises me is that it was named for the race car driver instead of the forgotten car mechanic or named the "Zaparka Flap" after the aerodynamicist who patented something similar in 1935.

A Gurney flap is a small strake that is perpendicular to the bottom of the wing located at the lower trailing edge. It influences the airflow around the wing by causing the airflow to bend towards the flap increasing the wing downwash and thereby lift. They are commonly sized around .01 to .02 of the chord length (optimal size is below the thickness of the boundary layer at the lower trailing edge – ref. 3). More thickness of the flap further increases lift but can cause the drag to rise as well. Tests done by Liebeck (ref. 1) showed the device increased lift and decreased drag around two dimensional wind tunnel models. Because of the lower speeds and smaller size of our models the impact for them is untested. I've made a small sketch to show how the gurney flap deflects the air downward near the trailing edge. The local airflow separates from the wing both in front of and behind the wing. The dividing line between smooth air and separated air is shown as a dotted line. The separated air makes the wing behave as if it was wider and had more camber. The downward deflection of the air acts just like a physical deflected flap.

The entire airflow around the wing is affected so the flap also increases the way the flow approaches the leading edge and ever important forward upper surface where most of the lift is generated. The Gurney Flap would be expected to change the trim of the model.

Related to the Gurney flap is the use of a small triangle in the same spot to accomplish this task. The Brown study, ref. 3, indicates that a triangle does not have as great a impact as a similar sized Gurney flap. I prefer a triangle because they provide adequate surface area to allow easy gluing under the trailing edge.

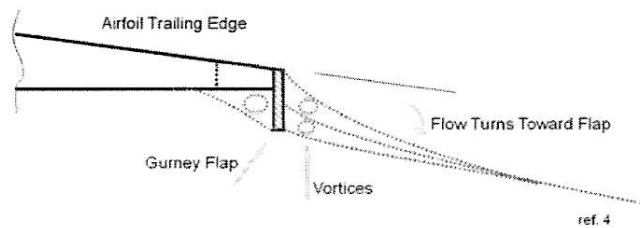

## Impact

The effects of changing your airfoil can be subtle and the impact overwhelmed by all the other facets of getting your model to fly right. Considering you have already solved the equation of properly fitting nose blocks, rubber and propeller combination, and solidly build but light structure then this is another facet to the model (I meanwhile am continuing to discover new bone-headed ways to fly the model including the recent favorite of "oh I'll just launch from here – why walk further upwind").

While carefully done test have shown some impact on improved lift compared to drag, I am immediately attracted to the capability to carry a heavier load from higher lift, and the stiffening effect of a perpendicular piece on a lightweight trailing edge.

I experiment with the amount of rubber that my models can manage. I built two dime scale models from the same plan at staggered times. One model for reasons that remain a mystery flew best on a modest rubber motor and would not tolerate my efforts to fly it with a heavier thicker motor. The second model readily accepts more power and motor weight leading to a longer higher powered flight (I leave it to you to consider which of the two thermaled better). The use of a Gurney flap to aid in producing lift could have an advantage in being able to shoulder more rubber weight for longer motor runs.

The addition of a Gurney flap adds to the structural depth of the trailing edge. The traditional trailing edge structure resists the pull of tissue forward but can deflect upward. The depth of the flap helps the upward bowing.

Because the effect from the flap is generated by the vortices and flow surface behind the wing the impact of air gusts and turbulence in wind is untested. According to Brown, the vorticies that produce the additional lift are rather unsteady and have oscillatory characteristics at low speeds. His measurements are a view of the time average of resulting forces. In our real world, gust and turbulence play a role. In addition, nice tests on a two dimensional wind tunnel airfoil give no indication of three dimensional spanwise flow. The vorticies behind a Gurney flap allow flow down the length of the wing. This might be important in highly tapered, swept wings, or in situations were one portion of the wing stalls locally. Airflow at one portion of the wing influences other positions. You'll just have to try something and see. Why should the aerodynamist and wind tunnel guys have all the fun.

## **Tried and True Testing**

The modeler should be aware that there is not much research at the low size and low speed regime where our models fly. Other than those who dream of the flying-machine exploration of Mars or the increasing horde of drone designers, most research has been focused on full size and fast airplanes. While others may wait for advances in science, computers, and specialized wind tunnels, I'm for getting some air under your wings and fly. Here is a way to do some tests.

Trim a model to fly absolutely straight in a glide with propeller removed. Then make the experimental change to one side of the model. Repeat the trial and carefully observe the model. Does it lift one wing more than the other inducing a turn. Does the change induce a stall with the resulting dropping of a wing. Does one side seem to have more drag causing a turn. This testing takes repeated launches because the effects might be subtle and subject to differences in launching technique. Don Srull and I did this with an old timer model to try to tame an otherwise horrid airfoil. Some careful testing and application of turbulators helped the situation.

You might consider doing this type of tests with an older model that has past its Kanone-grabbing days. What better way to learn something than with a model with which you have some experience.

### **Trimming Aid**

Stan Buddenbohm in his hand-launched and catapult-launched gliders has long advocated using wedges near the trailing edge to modify the models' trim. He argues that adding a short wedge makes for trim changes that are permanent, variable with a change in their length, and not subject to changes in humidity. I prefer thin edges that can be adjusted by breathing on them in my gliders but maybe it is just a case of old-dog-and-new-tricks. Jack Gore's superb rubber models frequently feature a short wedge (1 3/4" to 2 1/4" long by 1/16" to 3/32" thick) under one wingtip to help lift that wingtip during a portion of the flight. Such wedges increase the local lift on that section of the wing. The overall effect on the flight can be quickly tested using a wedge stuck on with glue stick and more permanently attached later.

The strength of the trim wedge is changed by the location, length of the tab, and tab thickness. If it doesn't work right, just change it. In this application a wedge or Gurney flap replaces unsightly paper tabs or tedious steaming over a kettle. Wash-in can be added by using a flap without building in wash-in or warping it in. Any place where you want to tailor the spanwise lift distribution these flaps are useful.

## **Unleash your inner scientist and experiment**

The most important contribution of trying Gurney flaps or wedges is to awaken your inner 12-year old and find a new way to experiment and have fun with your models. Trying new airfoils normally means building new wings but anyone can glue-stick on a Gurney flap to see what happens.

1. Liebeck, R.H., "On the Design of Subsonic Airfoils for High Lift," AIAA paper No. 76-406, July 1976.
2. Gieskieng, B., "Indoor H.L. Glider Section," Zaic Yearbook 1964-65, pg. 164.
3. Brown, L. and Filippone, A., "Airfoil at Low Speeds with Gurney Flaps," Dept. of Mechanical Aerospace, Manufacturing Engineering, UMIST.
4. Simperts, G., "Gurney Flaps", National Free Flight Symposium 1977.

## **The Wind Up** **Stew Meyers**

When you wind a rubber motor, it is constantly trying to redistribute the winds and knots into a minimum energy state. You can think of Hungorilla hanging in there to enforce this law of physics. There is a continual trade off going on between the basic twist and the knots. Tension plays a big role in this. When you stretch a motor and wind you are usually just putting in pure twist. As you relax tension knots form. That's the reason for stretching the motor as much as possible when winding. The release of energy during the unwind can be rather chaotic as the motor relaxes and tries to maintain a minimum energy condition while twisting the prop. Here Hungorilla is most active and may poke a hole through the side of you model with a knot.

Watching the dial on a wire torque meter gives you some clues as to what is happening when you wind a motor. That slow rise even rise is what you should be looking for. Tension is the other key variable. The preferred procedure seems to be stretch it out to five times the relaxed length and then try to wind at constant tension. With heavily braided motors you may notice a drop in tension as you start to wind. Extend the motor to return to the initial tension. I think this is the braiding turns rearranging themselves. At about 50% winds, start moving in while maintaining tension. You will notice a gradual increase in torque. Above 80% winds you may notice that more rapid increase in torque that warns you to stop before burst.

Watching the slope of the winding curve in real time on a P/C attached to the RTM gives one a much better feel as to what is going on. That critical change in slope above 80% is rather more distinct. The drop in torque as the winder is removed and the nose block is inserted into the rig is readily apparent. I have to run some more tests to see if a few hand winds just increases the starting torque point or pulls up the entire stored energy curve. My suspicion is that since we aren't packing in the extra turns with tension we are just redistributing some knots not really adding much energy.

Ideally you want a motor with the knots as evenly distributed as possible. By all means you don't want a bunch of knots climbing the prop hook or rear peg. Sometimes pulling the wound motor out and slowly reinserting it will help redistribute knots to a more benign lower energy state.

## Piscataway National Park Flying *Glen Simperts*

A small cadre of intrepid aviators have challenged the air just upstream from where Samuel P. Langley famously dunked his flying Aerodrome into the Potomac. There has been a half-dozen flying sessions at a hayfield at Piscataway National Park with about a half-dozen fliers. The large space of green hayfield grass is perfect for lots of flying fun. We have had visitors and always put a model in their hands for spreading the fun. The hayfield is within sight of the Wilson bridge and Mt. Vernon being about 15 miles South of the Washington Beltway. I have high hopes that this field works for us for frequent flying and local contests.

**The field:** The field is a hay field that is in grass of varying lengths. It is regularly cut to feed animals so some parts are longer than others. To my eye, the field size is approximately the size of the COMSAT site where the club flew for many years, but smaller than the Kudzu field in N.C. (roughly 1/3 mile long an 1/5 mile wide). The advantages of this field are the beautiful tall grass when needed, the close to D.C. location, the ability to invite more people and the public to the site, and the ability to have site-appropriate contests (as in the COMSAT contest of old).

**Surroundings:** The hayfield is surrounded by tall trees. There is a narrow barrier of trees between the field and the Potomac River. Larger stands of trees separate the field from swamps in two directions and the main farm activities on the fourth. It is located at a bend in the river and has unique Micro climate winds.

**The Location:** The field is in Accokeek MD near the Potomac River. From the Washington Beltway you would travel south on MD 210 (Indian Head Highway) about 15 miles. Take the Bryan Point Road exit near Accokeek MD. Bryan Point Road dead ends onto the National Colonial Farm (maybe 4-5 miles). The access point is not quite that far. One of our Maxcuters, Jonathan Wright, works at the site and arranges for driving access to the center of the site. Fliers meet at a specific time and Jonathan opens a gate for access. Walk-on access is also available across a 4/10 mile level wheelchair accessible boardwalk.

**Suitable Models:** The Park and the foundation that operates the site is dedicated to environmental education so flying activities have to meet the quiet low impact world-view of the community and other users of the park. Rubber-power, small electric aircraft, and gliders suit the site. Gas-powered aircraft and RC aircraft are not allowed. Neither is the use of DT fuzes (it is a hayfield which frequently has dried grass). The site is under the flight paths of National airport and the helicopter corridor used by military aircraft.

**Amenities and challenges:** There are no amenities. Bathrooms are available at the nearby National Colonial Farm.

Our winter schedule for flying will be organized around the prediction of suitable weather. I will examine the weather forecast about three days out and send out a notice to airman. Let me know if you would like to receive these notices and if you plan to join us. We have tried both Friday evenings during the summer and most recently Sunday afternoons. We can try other times of the week. Jonathan coordinates our activities with the operations of the site. Send me an email if you would like to join in the fun. Invite your neighbors and any newcomer who would want to try free-flight flying.

Glen Simperts , grfreeflight@hotmail.com

## Calvary Gospel Gym Flying

A small gym is available for indoor flying in Waldorf, MD on Tuesday from 10:00 to Noon. Located at the Calvary Gospel Church, 11150 Berry Road (MD Rt. 228), Waldorf, MD the gym is the size of a basketball court with retractable hoops and bleachers. The center of the pitched roof is perhaps 35-40 feet with one cable running across the center at the 25 foot level. There is a locked announcer's booth with an open front that can trap a model until freed (usually the model can be returned at the next flying session). It is perfect to getting your NoCals, Pennyplanes, A-6s trimmed on low power or half motors. Dimers and scale models will be challenged by the size of the gym. Light electric RC flying for those light and slow fliers. Low ceiling gliders can make use of the space.

### PHOTOS PAGE 19

Julie Farrell photos

1. Owen Houck, Mark's son, was the most active flyer at WaWa this year. He literally had to be dragged off the field at the end of the day.
2. The DC Maxecuter contingent at the Fall Kudzu meet. Dave Franks, Wally Farrell and Frank Rowsome.
3. Frank demonstrates a winding technique I am not familiar with..
4. Abram Van Dover came down from Hampton, Va.
5. Jimmy Jordan, one of the co-CDs helps his grandson Matthew get ready for WW2.
6. Good to see Bill Shepard show up. John Diebolt, the other CD mans the table.
7. Frank Rowsome helping Dave Franks. who vows he will continue to fly models as long as he is on top of the grass.



1



4

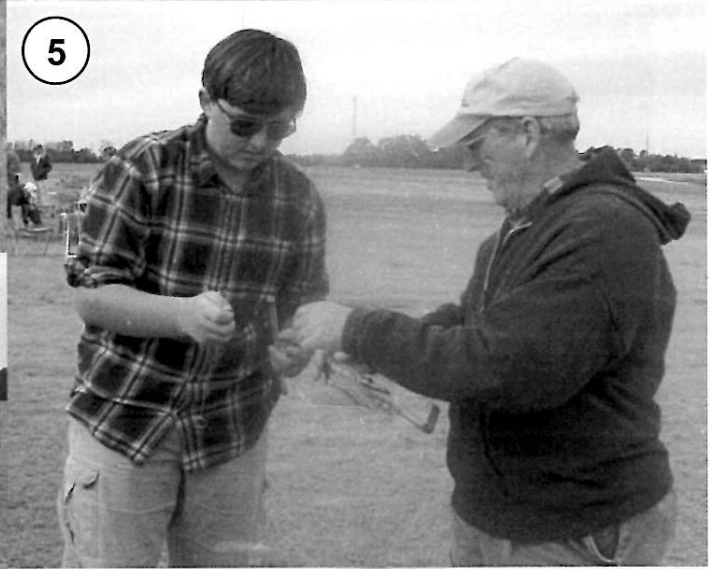

5



2



6

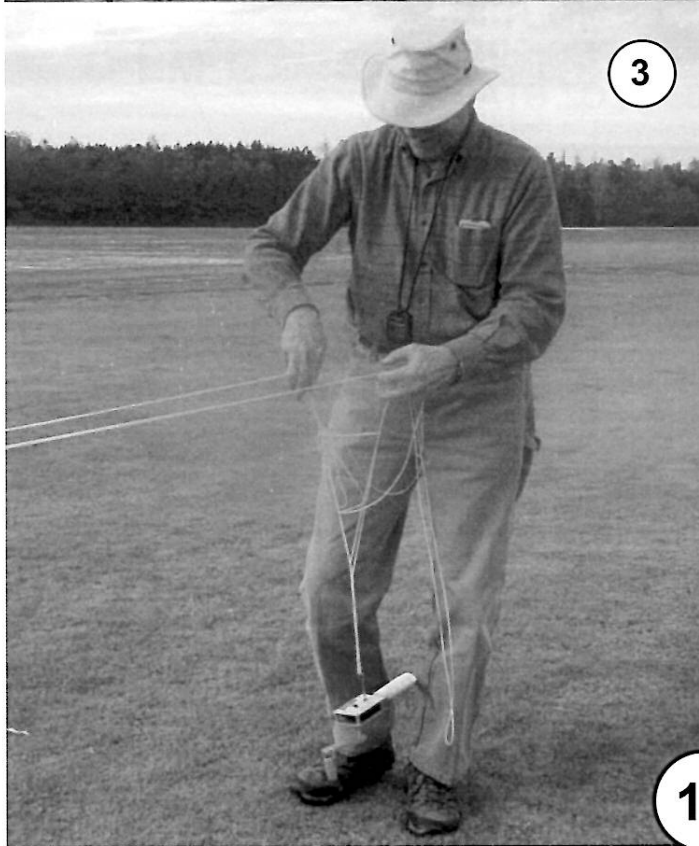

3



7

19



D. C. MAXCUTTERS  
% STEW MEYERS  
8304 WHITMAN DR.  
BETHESDA, MD 20817

PRSR STD  
US POSTAGE  
PAID  
PERMIT 6388  
SUBURBAN MD

**CONTENTS:**

- DIME SCALE HELLDIVER**
- PROFILE STAGGERWING**
- WAWA 2014 RESULTS**
- NOV HURRICANE RESULTS**
- GURNEY FLAPS**
- PISCATAWAY SITE**
- RECORDING TORQUE METER UPDATE**
- THOUGHTS ON WINDING**

2\*3\*\*\*\*\*ALL FOR ADC 210  
201502  
Mike Escalante  
212 Division Ave  
Hagerstown MD 21740-5040

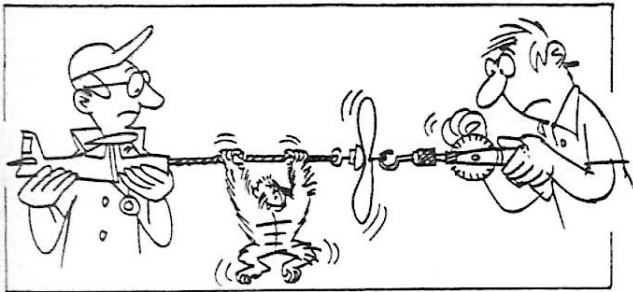

"HUNGORILLA"

BILL MILLER

**OR CURRENT RESIDENT**

**You can now renew on line!**  
**Go to MaxFax on the website**  
**[www.dcmaxecuter.org](http://www.dcmaxecuter.org)**

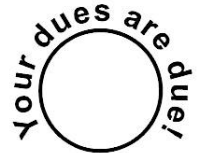

**UN-BRAIDED POWER PLOT**

6" X 1/8 X 4 CORKY'S 383 TURNS  
6" HOOK LENGTH 8" PECK PROP  
75% WINDS 2.63 IN-OZ START

Source: 11-11 UB TEST 2.xls

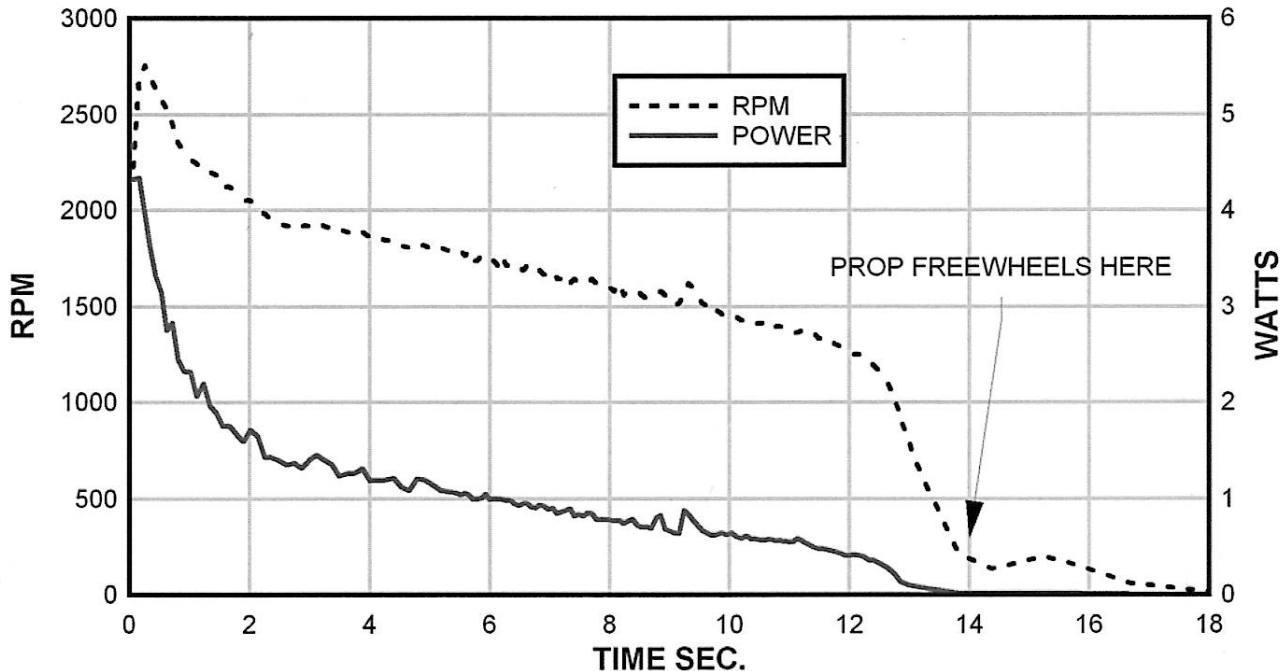



# STAGGERWING

*Beechcraft D-17*  
 1/4 A FF sport model

BY BUD OVERN  
 PLANS - DOTTY C.

CENTER OF GRAVITY  
 INTERPLANE STRUT  
 3/32" Balsa

TO QUALIFY AS AN EBENEZER USE FLAT PLATE WINGS, I WOULD LEAVE THE LANDING GEAR OFF. YOU COULD ALSO USE A SMALL ELECTRIC MOTOR FOR POWER. OF COURSE THIS MODEL COULD BE BUILT AS A 3 CHANNEL MICRO RADIO JOB.

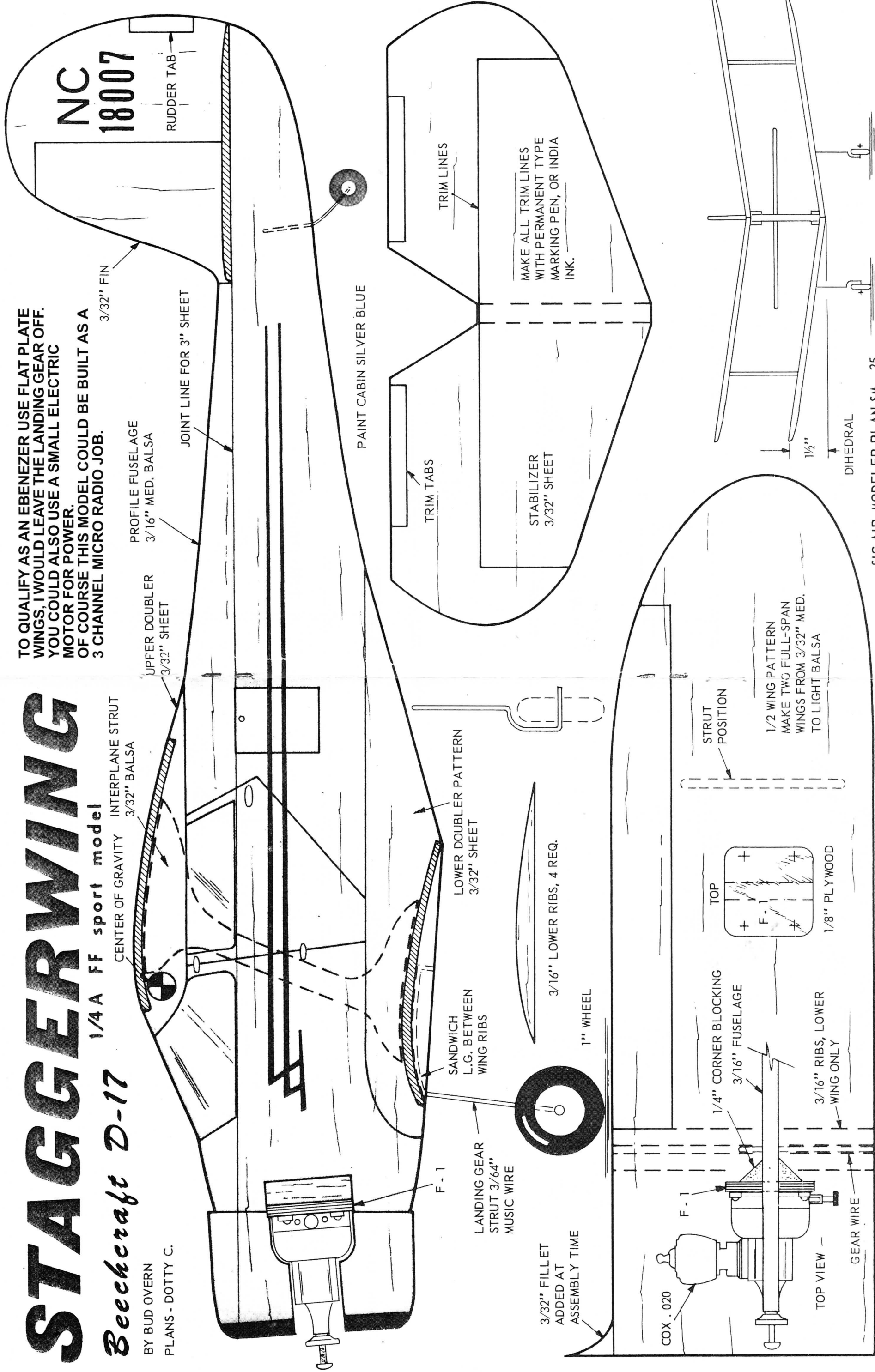

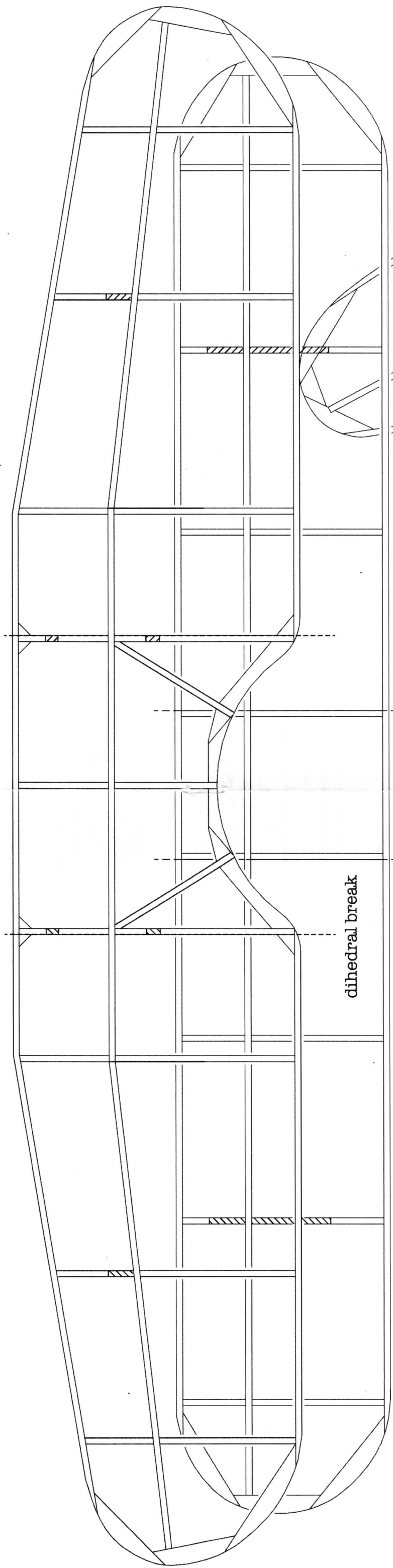

dihedral break

1/2" dihedral  
at last rib, each tip



dihedral break

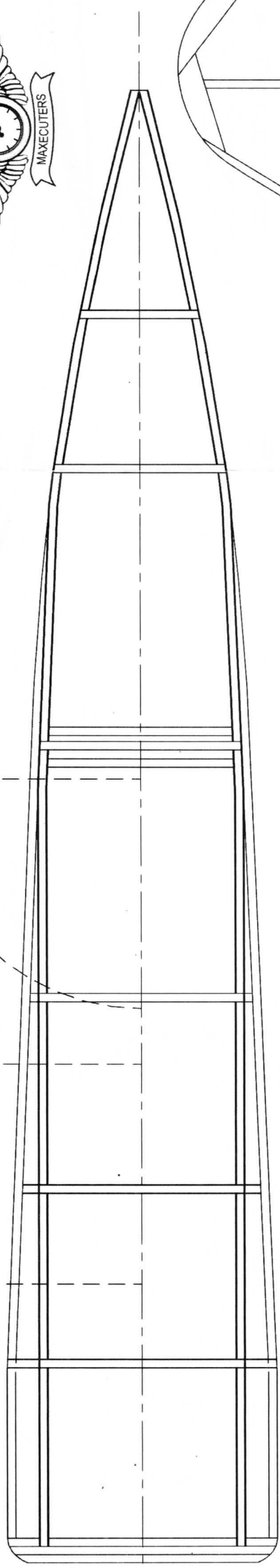

All construction 1/16" sq. stock or 1/16" sheet

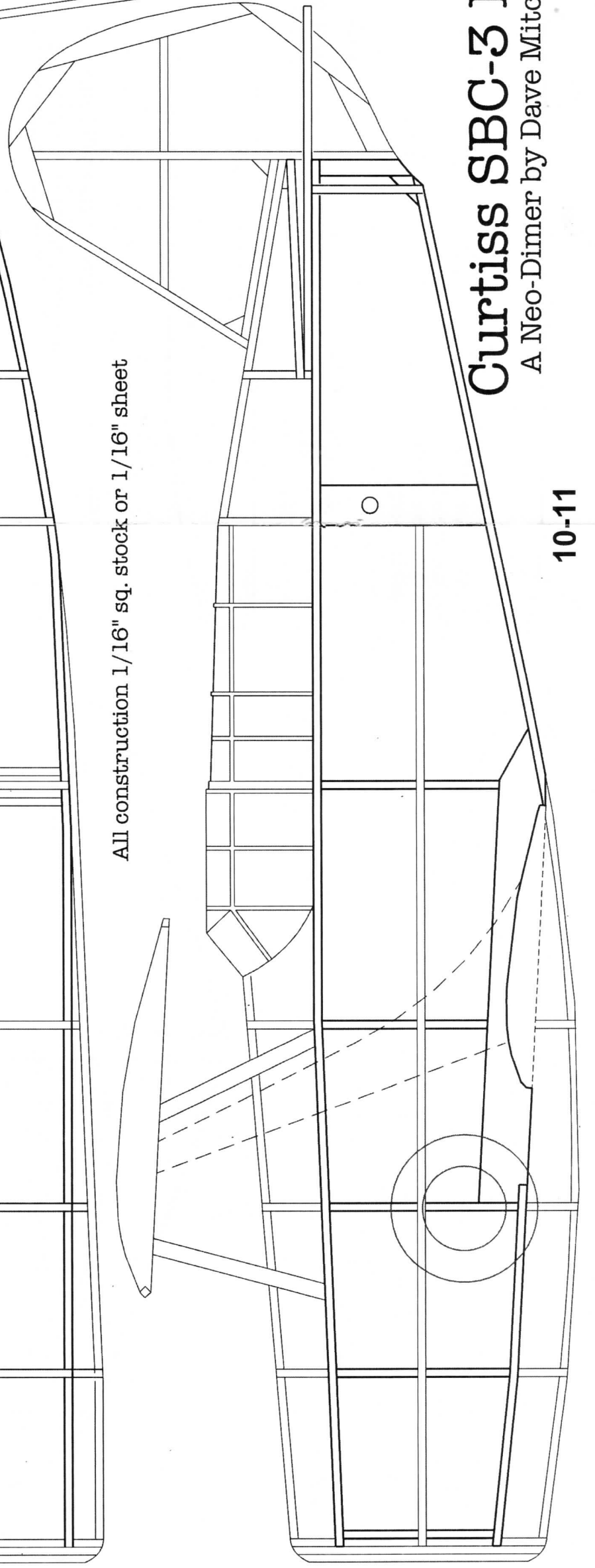

# Curtiss SBC-3 Helldiver

A Neo-Dimer by Dave Mitchell