

MAX FAX



Journal of the D. C. Maxcutters

... home of the dreaded POTOMAC PURSUIT SQUADRON of the Flying Aces

Editor: Stew Meyers

2015-5



LAMBERT MONOPREP ISSUE

COMING ATTRACTIONS

**INDOOR FLYING HAS RESUMED AT BAUER
MON & WED 12:45 TO 2:15 PM**

14625 Bauer Drive
Rockville, Maryland 20853
240-777-6922

**MARCH 8 2015 NATIONAL BUILDING MUSEUM
SAME EVENTS AS IN JANUARY**

**MAY 16 SAT & 17 SUN, 2015 KUDZU KLASSIC
RAEFORD, NC FLYER IN THIS ISSUE**

**MAY 30 SAT & 31 SUN SPRING WAWA CONTEST
DETAILS TO APPEAR ON FAC WEB SITE**

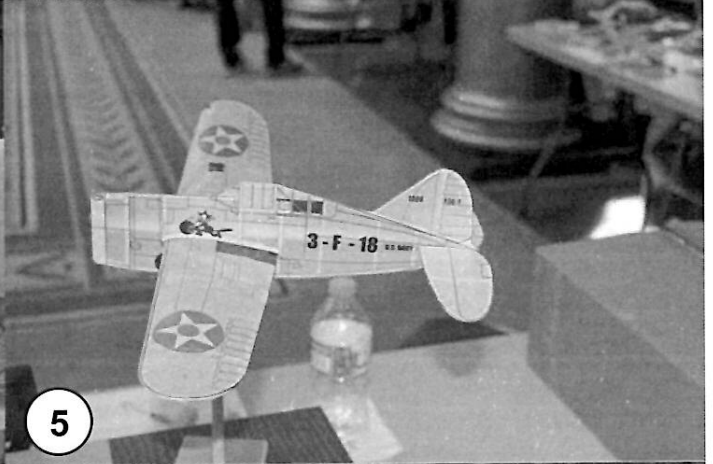

MaxFax 2015- 1

NOTE - WE HAVE GONE FROM
BIMONTHLY TO QUARTERLY

Stew Meyers Editor

MONO-PREP ISSUE

Alan Schanzle, a long time Maxecuter and former editor of MaxFax, was elected to the FAC Hall of fame last year. He gave me a couple of his original plans for publication a few months ago. I forwarded one to the FAC Newsletter and am publishing the Mono-Prep here. Along with Alan's plan is a Peanut plan from Model Builder that he mentions. (In the 1960's I was part owner of a Culver Dart, the follow on to the Mono-Prep, for a short while. The Lambert engine failed on take off leading to a crash that fortunately only damaged a couple of egos and a wing spar. The plane was rebuilt and sold soon there after.) We also have the results from the January NBM contest with some spectacular photos, including some by Robert W. Madden, a professional photographer. There is a flyer for the May Kudzu contest. We also take a look at the Foo Fighters beginner program run by Scott Richlen. Finally the revised GHQ peanut rules are presented.

Lee Campbell called me to let me know that he has had to sell Campbell's Custom Kits due to illness. Fortunately it has been purchased by Mark Freeland of <http://retrorc.us.com> RetroRC. Mark is a supporter of free flight, I talked to Mark and he will be moving to laser cut them. The stock is in the process of being moved and has not yet appeared on his web site.

Incidentally SkyLake models has evidently been resurrected. As <http://www.skylakeworkshop.com/> and has the dimescalers, but not the larger models. Wally has successfully ordered from this site.

P2 PHOTOS from NBM by Julie Farrell

1. John Appling with some of his fleet at the NBM.
2. Dave Mitchell with his fleet. The tri-motor No-No-Cal Owl put in its first real flights. It does fly!
3. Thomas Schill with his TSA plane.
4. Oliver Sand's Banana Bostonian came in second..
5. One of several Howard Littman Brewster no-cals (<http://hjlmodels.com/index.html>) That showed up.
6. Bill Shepard with his Limited Pennyplane.
7. John and Mark Houck came down from PA. Stefan winds with his back to us.
8. Brett Sanborn with his winning A-6. Wally watches his Phantom Flash. The crumb snatchers in the background are ready to pounce on any model landing near them.

MEMBERSHIP - Dues for membership in the DC MAXECUTERS are **\$25** per year for residents of the USA, Canada, and Mexico, and **\$35** for all other countries. You may now use PayPal at the website: **www.dcmmaxecuter.org**

Your mailing label indicates the year and month of the last issue of your current membership. An "X" in the box below is a reminder that your dues are due. Send a check, payable to the "D.C. MAXECUTERS", to the treasurer, Stew Meyers.

PUBLISHING DATES - Four issues of MaxFax are sent each year, one each quarter, but since this is a volunteer publication nothing is guaranteed except that four issues will be sent to all members. ***(Rising costs and dwindling membership have forced us to go to four issues a year as of 2014.)***

CONTACTS - Material for the newsletter and membership questions should be addressed to Stew Meyers phone 301-365-1749. Email gets immediate attention. stew.meyers@verizon.net

Louvers *Dave Mitchell*

Louvers are pretty simple, really. First lay the vellum out over the fuselage to get positions. Draw a line at the rear "open edge" of each louver. Lay the vellum on a cutting board and use an x-acto to cut a slot in the vellum at the line down for each louver. Then with the paper on a hard board, hold a sharp edged ruler about a 3/64" away from, and parallel to, the cut. With the ruler firmly held down, work a sharpened round toothpick into the slot, and use it to raise the louver. You have to be careful not to push it beyond the edges of the slot or it will tear the opening. You're also looking to get the paper slightly creased at the ruler edge that's what helps to hold the rise in the louver. A toothpick's end will do this very well so long as you keep that ruler edge firmly in position. What you are doing here is stretching the material very similar to full scale practice. Paper, like aluminum, will stretch but not shrink. A small drop of thin cyano applied at the corners will stiffen the louver. In the example below louver panels for the Lloyd 40-16 are made from bond paper rather than vellum and then sprayed aluminum.

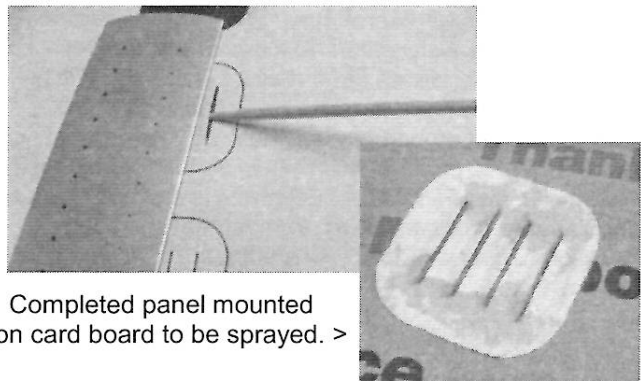

Completed panel mounted
on card board to be sprayed. >

The Lambert Aircraft Corporation Monoprep

Allan Schanzle

Have you ever heard of the Lambert Aircraft Corporation in Robertson, Missouri? Probably not, and neither had I until I saw a photograph of their Monosport in the December 1936 issue of FLYING ACES. The registration on the rudder was not very clear, (see Photo 1) but under significant magnification it appeared to be X1179. The text indicated the Monosport was an upgraded version of their previously built Monoprep. I looked for a 3-view of either plane and found one for both the Monoprep and Monosport in J. W. McDonald's book titled AIRCRAFT YEAR BOOK 3-VIEW DRAWINGS, 1903-1946 (Figures 1 and 2). This prompted my search for the origin and evolution of these two planes.

I reviewed my files for previously published models and found that a plan for the Monoprep had been published by W. L. Kincheloe in the November 1933 issue of MODEL BUILDER. The author of the article notes that the Monoprep had been designed by Al Mooney in 1935 for the Lambert Aircraft Corporation. He also recalls visiting the St. Louis airport in 1936 where he saw a yellow and blue Monoprep with registration X11791. Note the "1" at the end of this registration. It may exist in the FLYING ACES photo, but it certainly is not as clear as the two numeral 1's prior to the "79" in the registration. More will be said about this later.

Kincheloe continues by noting the Monoprep was modified by adding an enclosed cockpit as well as other minor changes, and at that time, the name was changed to Monosport, but the registration number was retained. Several airframes were started. Al Mooney left the Lambert Aircraft Corporation and joined with Knight Culver, a dealer for Monocoupe aircraft, to form the Dart Manufacturing Company. They bought the design, parts, and tooling from the defunct Lambert company and moved the production to Columbus, Ohio. The company was renamed the Culver Aircraft Company in 1939. Compare the 3-view for the Culver Dart, (Figure 3 below) to that of the Lambert Monosport (Figure 2), and you can see the similarities. In summary, the Lambert Monoprep, designed by Al Mooney and presented here in model form, led to the Lambert Monosport, which in turn became the Culver Dart.

Perhaps it is now possible to resolve the concern of the registration number that appeared in the photo of the Monosport shown in FLYING ACES. Juptner's books dealing with U.S. Civil Aircraft have an extensive review of the origin of the Culver Dart. In the presentation for Approved Type Certificate #674 (Culver Dart), there is a list of all Darts and a photo of the original one that evolved from the Lambert plane (Photo 2). The registration in this photo is NC-11791. So it appears that the last digit in the FLYING ACES photo is just not distinguishable. Note, however, that Juptner's registration begins with "NC", 'while that in FLYING ACES is "X".

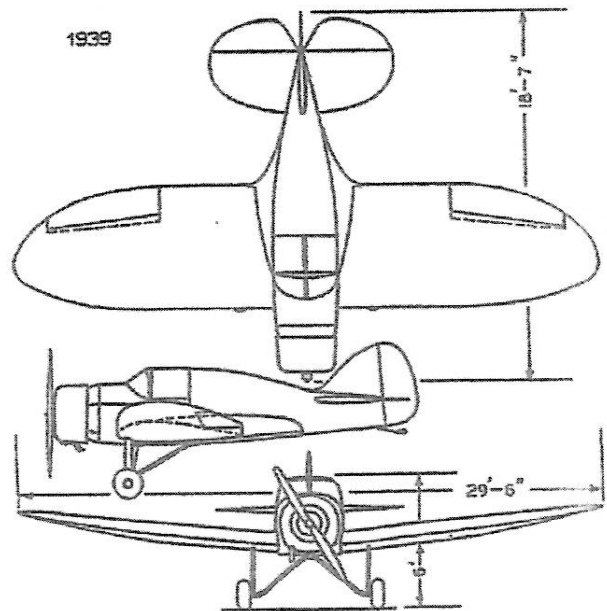

Figure 3. Culver Dart GW 3-View

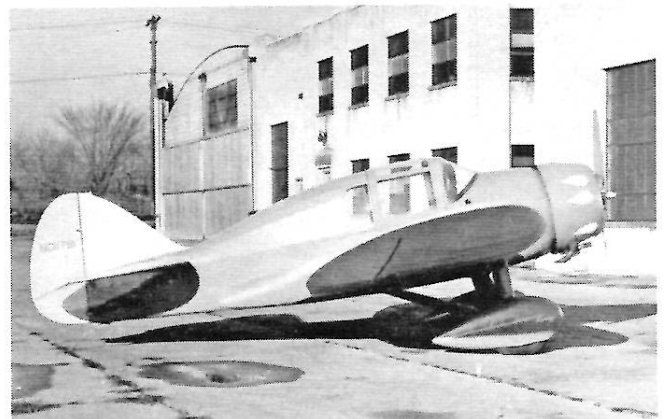

PHOTO 2 Juptner's U.S. Civil Aircraft

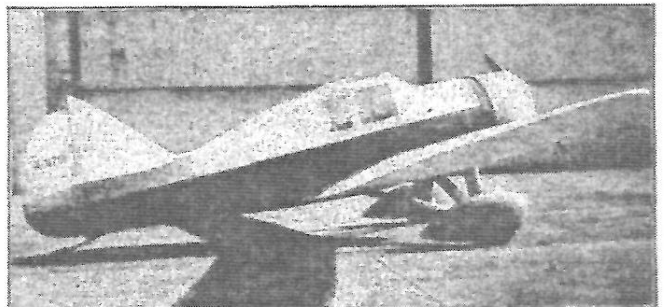
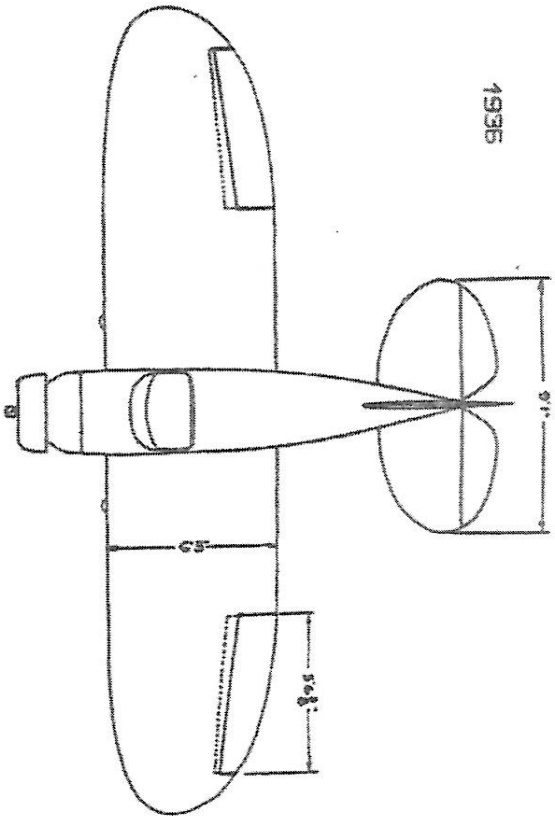
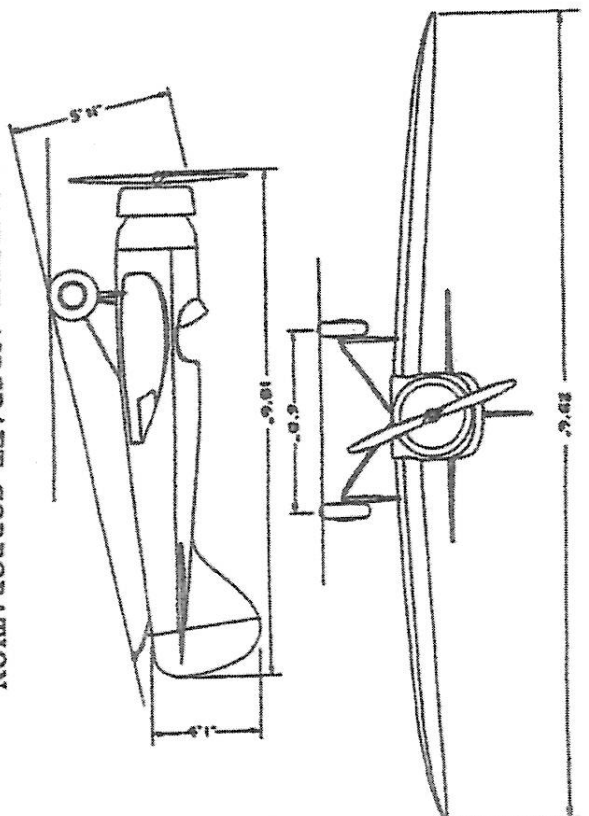

PHOTO 1 Flying Aces December 1936



1936



LAMBERT AIRCRAFT CORPORATION
 Robertson, Mo.
 NEW MONOPHRE—OPEN TRAINER — 2 PLACE
 ENGINE: LAMBERT R-266 90 H.P.

Figure 1.

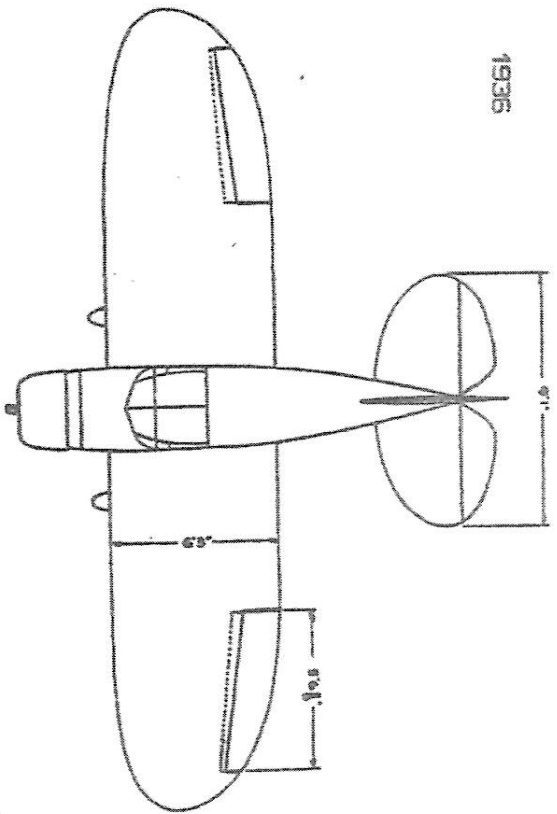

1936

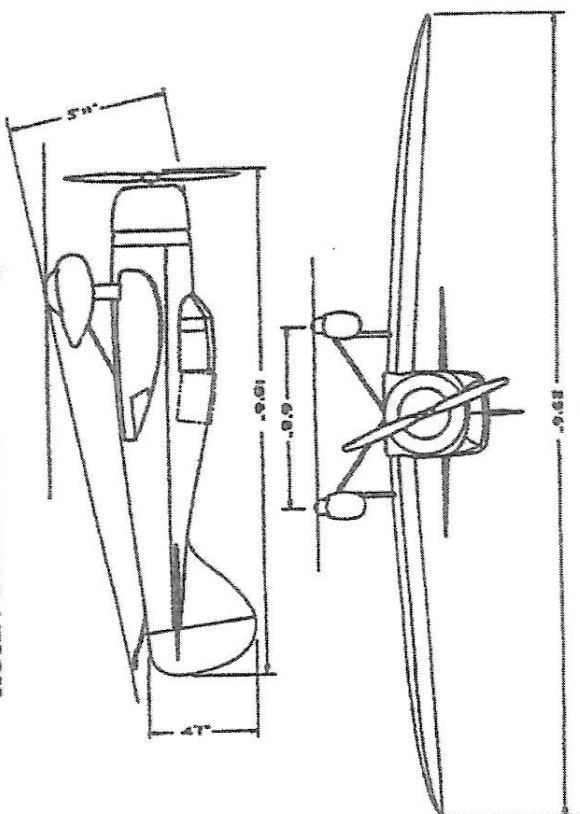

LAMBERT AIRCRAFT CORPORATION
 Robertson, Mo.
 NEW MONOPHRE CONVERTIBLE—SPORT MODEL DELUXE — 2 PLACE
 ENGINE: LAMBERT R-266 90 H.P.

Figure 2

1935 LAMBERT MONOPREP

BY W.L. KINCHELOE • PHOTOS BY BILL HANNAN

The Monoprep was designed in 1935 by Al Mooney for the Lambert Aircraft Corporation of Robertson, Missouri. During one of my weekly visits to the St. Louis airport in 1936 I saw a yellow and blue low-wing open two-seater with a radial engine, oversized tires and the wing number X11791—the prototype Lambert Monoprep. In 1937 the design was modified by raising the turtledeck and adding a sliding cockpit enclosure. The name was changed to Monosport, but the number X11791 remained. Lambert started building three Monosport airframes when Knight Culver bought the design, parts and tooling and moved production to the Dart Boat Works in Ohio. The whole complicated story is covered well in John Underwood's book *Of Monocoups and Men* and by Jim Alaback in his write-ups of the history of the Dart GW.

I fell in love with a black and red Dart that provided my first dual flight instruction in 1938. The Dart had a personality that was forever engaging. In 1943, now a student at Parks Air College where two Darts (of an original five) were used in the flight training operations, my association with the Dart continued. In the school library, in *The Aircraft Yearbook* for 1937, I found a three-view that looked remarkably like the Dart but was identified as the Lambert Monosport. There, also, was a three-view of the Lambert Monoprep. I started to make a layout for a CL model of the Monosport/Dart in the summer of 1943, but my local draft board had other plans for my spare time despite my student deferment.

Walt Mooney's Peanut model of the Dart appeared in *Model Builder* in 1975, and later, I saw a beautiful 1/4-scale RC model of the Dart at a fly-in in California. It had been done; and at both ends of scale. Then it struck me: no one had built a model of the Monoprep. During discussions with Bill Hannan it came out that he had the original ink-on-linen drawings by Harry Pack that had been used in *Aero Digest* and the *Aircraft Yearbooks*. My proof-of-scale rests on the yearbook illustrations, one of which is included with this article.

The model presented here is the result of nearly a year of spare time design and test activities. First, using the original drawings, a Peanut-sized layout was completed. Next, areas and weight estimates were calculated and the airfoil selected (Clark-Y). Next I built a

proof-of-principle all-balsa profile model with a flat plate airfoil as a pleasant and inexpensive way to learn about the design's stability and performance potential without the time, expense and aggravation of building the complete model. After the POP model flew, the working plans for the final Peanut were drawn up and the structure detailed. The prototype model shown here came in at a trifle over 21 grams—a bit heavy. Despite my best efforts, the model was nose heavy. Therefore, I've replaced the carved basswood propeller shown in the photographs with a Larrabee-profile bent wood prop, and have included a blade pattern on the plan. It should enhance performance and does reduce the overall weight. One important point: do not yield to the temptation to replace the hardwood wheels with balsa or some other lighter alternative! The center of gravity on the plans is shown in the highest, most rearward position for stable flight with the angular setup shown. I carved a block to the contour of the windshield and heat-molded the windshield from thin clear plastic taken from a bubble-pack. This eliminated the frustrating experience of trying to hold a springy plastic part in place while the glue dries.

The wing and tail outlines can be made either from laminated basswood around a form or cut from sheet balsa. Mount the landing gear to the stub ribs R2 with epoxy before covering the wing. The Lambert R-266 engine is modeled using paper tubes formed on a dowel and wrapped with thread to simulate fins. The pentagonal crankcase is a piece of hard balsa. License numbers were printed on a CAD setup and then transferred to tissue in a copy machine. This method has minimum weight penalty and reproduces fine details well. Be sure that the tissue is taped carefully to a sheet of plain paper to carry it through the machine. The numbers won't run when doped if the dope is sparingly applied with an airbrush, or if pre-doped tissue is run through the copier. Every part of the model is covered before assembly except for the wing mount area of the fuselage. A sub-structure of three pieces of F2 can be built and covered after the wing is installed in the fuselage. The model should have a noticeable wash-out in the wings as a result of lifting the leading and trailing edges to meet the straight spar. Be sure that both wings have the same wash-out. The thread representing the central landing gear struts is added after all covering is complete. When all this is done, add the hardwood wheels with brass washers and a drop of solder to retain them. This will help keep the center of gravity low. I used four strands of .037-inch square rubber, barely slack, for my first trial motor. You might want to try two strands of .045 with noticeable slack. If the model balances as shown on the plan, the indicated angular alignment hasn't been changed, and there aren't any serious warps, it should fly reasonably well on the first low-power attempt. A short-coupled low-wing airplane can be made to fly!

LIFTED FROM THE NOV 1993 ISSUE OF
MODEL BUILDER.

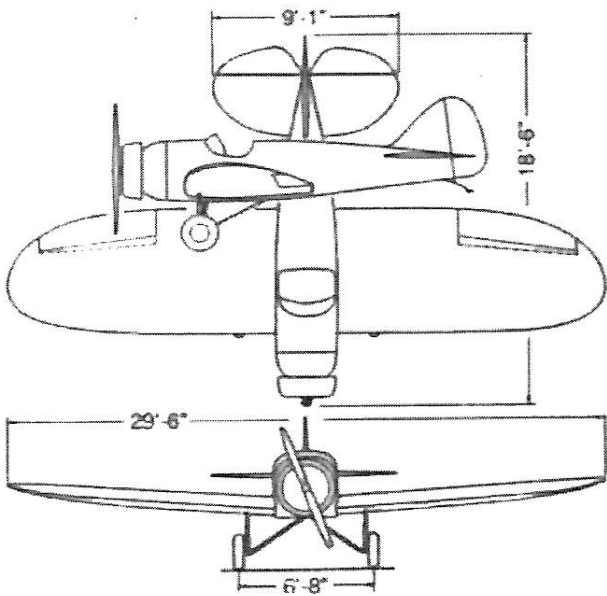

Copy of page 295 from The Aircraft Yearbook for 1937, a publication of the Aeronautical Chamber of Commerce of America, Inc., New York. The original of this three view by Harry Pack is presently owned by Bill Hannan and was used to provide the outline for the plans of the Monoprep Peanut.

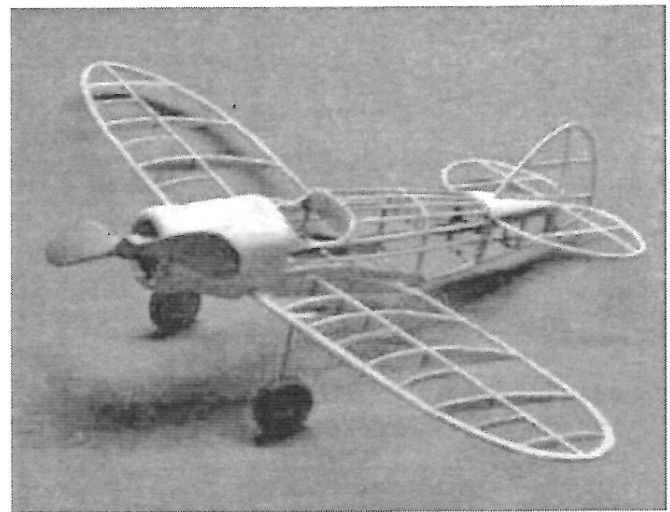
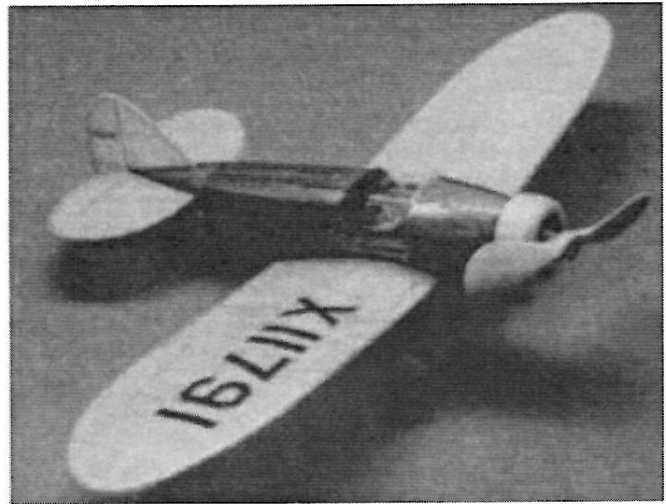

< Left- Lambert prototype Monoprep X11791 in 1935 later modified into the prototype Monosport. NC11791 in 1937.

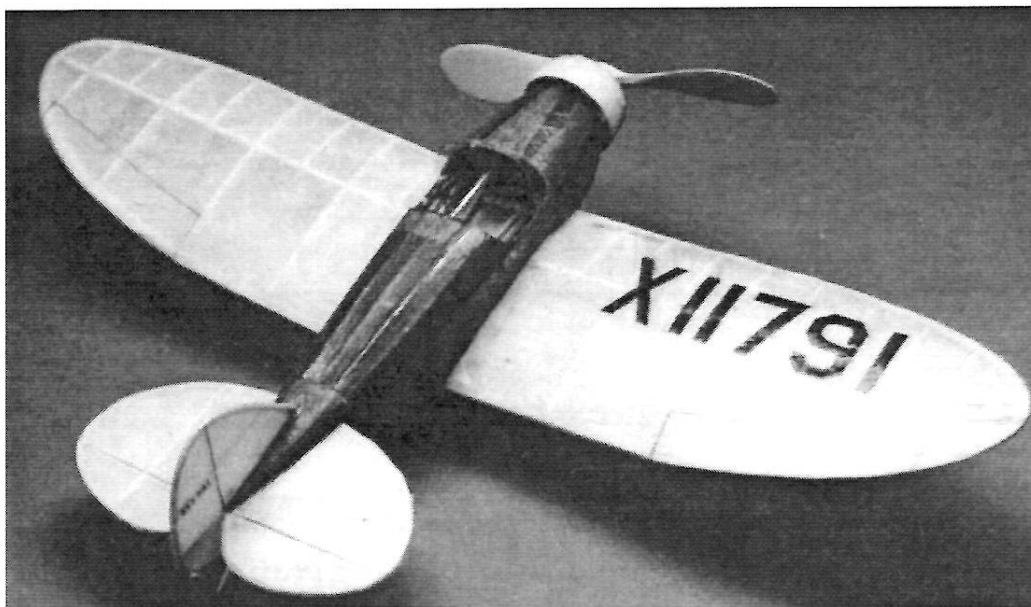

Above-
The author's Monoprep -in the bones.- The landing gear is scale length and wheel diameter, there being no hope of making a presentable extension for R.O.G. takeoffs with a flying propeller. This model used cut sheet balsa wingtips and bent basswood laminated tail surface outlines

Other photos -Model Builder Peanut Monoprep.

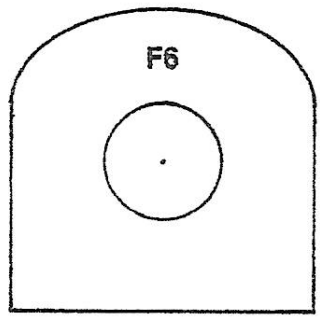
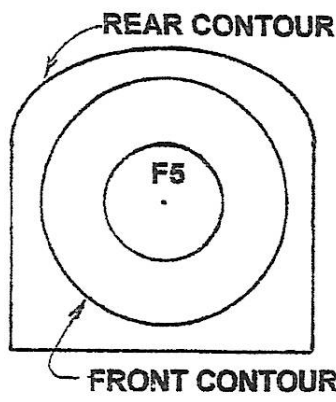
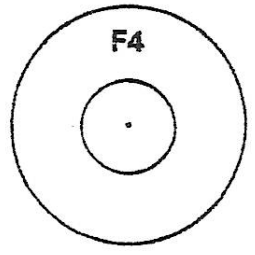
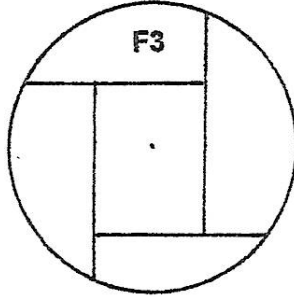
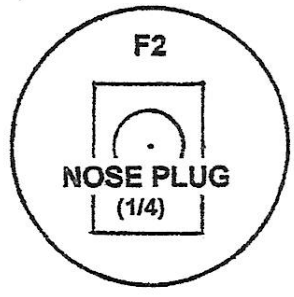
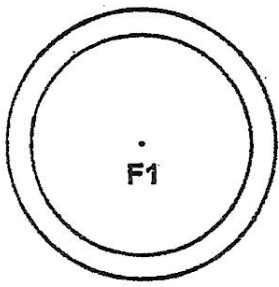

1/16x1/32 1/16 SQ

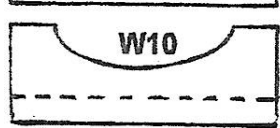
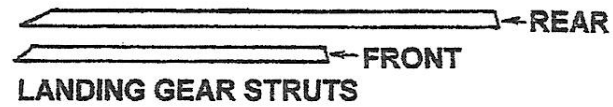
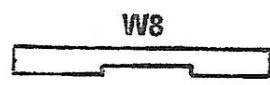
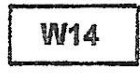
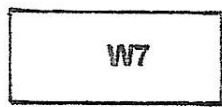
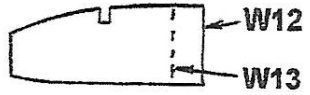
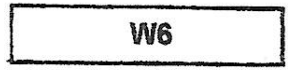
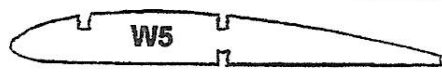
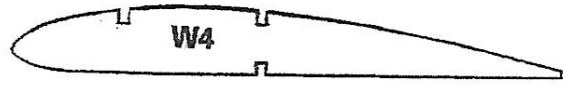
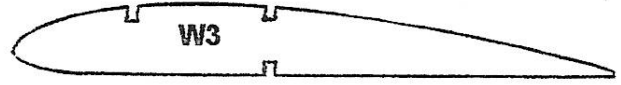
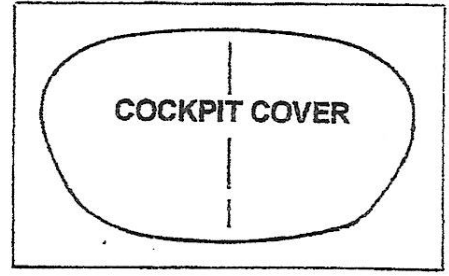
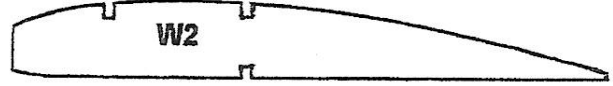
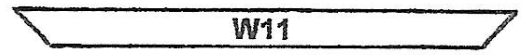
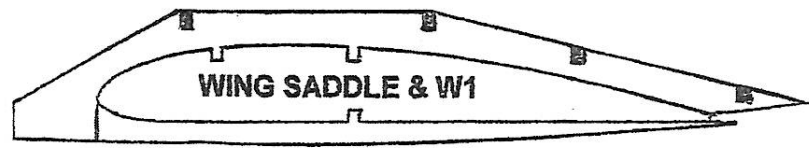
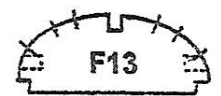
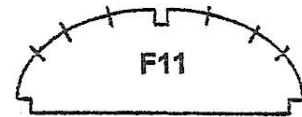
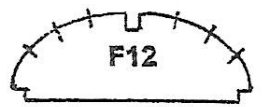
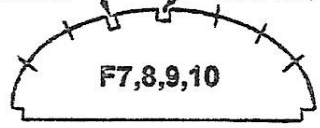

Lambert Monoprep Patterns

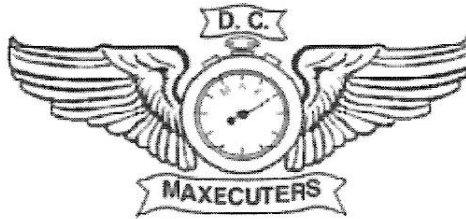

KUDZU KLASSIC May 16-17 2015

RAEFORD, NC

Saturday May 16

Sunday May 17

Mass Launch

WWI
Navy Scale
Modern Civi I& Military

WWII
Combined Racers
Golden Age Biplanes & Monoplanes

Judged and Timed

Embryo
FAC Jet Catapult
Dime Scale
Simplified Scale
GHQ Peanut

2 Bit+1 Old Time Rubber
Low Wing Trainer
No-Cal
FAC & Pnut Scale Combined
Phantom Flash

AMA Events

Classic Towline Glider
AMA Catapult Glider
AMA P-30 Rubber

E-36 Electric*
E-20 Electric*
SAM Twin Pusher Mass Launch

Lunch will be served on the field Saturday

CD /CONTACTS:	FAC Events:	Stew Meyers	stew.meyers@verizon.net
		301-365-1749	
		Dave Mitchell	davedge@me.com
		202-744-9345	
	AMA Events:	John Diebolt	jdiebolt@mindspring.com
		919-467-1025	

For more information: www.carolinafreeflight.org www.dcmxecuter.org

Google Map to field: <http://goo.gl/maps/vc3R>

Take US-401 / Raeford Rd. WEST out of Fayetteville. After the Food Lion shopping center on your left, US-401 divides; bear LEFT (south) on to US-401 Bus. Go 2.6 miles, turn LEFT at Oakdale Gin Rd. Go .4 miles, turn LEFT at Ratley St. Ratley makes a 90 degree bend to the left; at this point the field and dirt access road is on your right.

Foo Fighters

Scott Richlen

The Foo Fighters, Squadron #75 of the Flying Aces Club is a unique squadron as far as I know. It is designed to teach building skills to young people using simple free flight models as their building subjects. The membership of the Foo Fighters Squadron consists primarily of junior high students with a few mentoring adults. As opposed to other model airplane clubs (and I suppose FAC squadrons) membership of adults in this squadron is limited to those who are willing to spend their time teaching young people how to build free flight models.



The selection of models that we build is based on the idea of starting out simple, but then providing increasingly difficult building challenges with each new model built. We start off with a kit build of the Delta Dart. We follow that up by doing a scratch build of the Delta Dart. The purpose of the scratch build Delta Dart is for the student to review what he has just done in building the kit Delta Dart and to give him a stronger idea of the building process. Our next build is the Z-15. The Z-15 is slightly harder to build than the Delta Dart, but it's a better flyer and it uses the Delta Dart nose piece. It is also built slightly different than the Delta Dart in that the framework is constructed separately from the covering (remember in building the Delta Dart how the sticks are both glued to each other and to the covering?) and then the covering is applied with a glue stick. The next build takes another small step up: the Yard Ranger. Like the previous builds, the Yard Ranger is stick built with a flat airfoil, but the student has to manufacture the nose piece from tubing, wire, and thread. After the Yard Ranger build the student builds a Unicopter. The Unicopter is a very simple helicopter: stick built, but the student has to sand an airfoil into the helicopter blade and has to manufacture a nose piece just like he did on the Yard Ranger. The Unicopter is not a great "flyer" going mostly straight up and then flopping around on its way down; however, it is a lot of fun to play with. The next build is a No-Cal. We choose these from the Paul Bradley

website. He has a bunch of downloadable plans for No-Cals and he also has the "skins" that go along with them. The skins are PDF files which you can use in your inkjet printer to print on Japanese tissue to create the covering for the No-Cal. Last year we built a P-40 Flying Tiger No-Cal while this year we will be building a P-51D.

The Foo Fighters Squadron meets once a week as an after school activity. This is the second year that we have operated. The first year, in the fall of 2013, we started with nine or ten students and by Christmas we were down to two students. So in February, 2014 we started up a new class along with our two "surviving" students and by spring we had four students who had finished their P-40 No-Cals. This fall our four students from last year returned plus another eight new students. At this point in the school year with typical attrition we are down to our four students from last year plus about five or six survivors from this past fall. Working with Junior High kids is an interesting situation: you never quite know who will turn up at any building session. The kids are a bit on the "flighty" side. However it seems like we always get a few that become very, very serious about their building. They really seem to enjoy it and thrive on it.

Over the years I've heard many older model airplane people complain that young people weren't interested in model airplanes. However I found that is just not true. There are always a few children who are very interested in model airplanes and very interested in learning how to build model airplanes. Unfortunately the culture that they live in each day provides them very little in the way of guidance or training in building model airplanes. It is clear to me that almost every junior high school has a minimum of five or ten children who would love to build model airplanes if someone would just come and mentor them. Many of the local junior highs have after school activities and would be very happy to have some adult mentors come in and teach their students how to build model airplanes. This is particularly true if they are led to recognize that model airplane building is very supportive of the Science Technology Engineering Mathematics (STEM) subjects that all schools are very concerned with these days.

The Foo Fighters are fortunate to have an interested sponsoring teacher, Eddie Alfaro and another Maxecuter, John Murphy to assist Scott Richlin with the program. This year they got the use of a trailer formerly used as an emergency class room as a club house.

Z-15 Jigs.

These make building the Z-15s a snap and take the guess work out of getting the dihedral correct and of aligning the pylon. On the left is the jig for gluing the two wing panels together at the correct dihedral. Notice that it has the center section taped so we don't end up gluing the wing panels to the jig. I've also marked it for correct panel positioning. You can do wonders with just some cardboard and a hot glue gun! On the right is the jig for aligning the pylon. This is used after the dihedral jig...

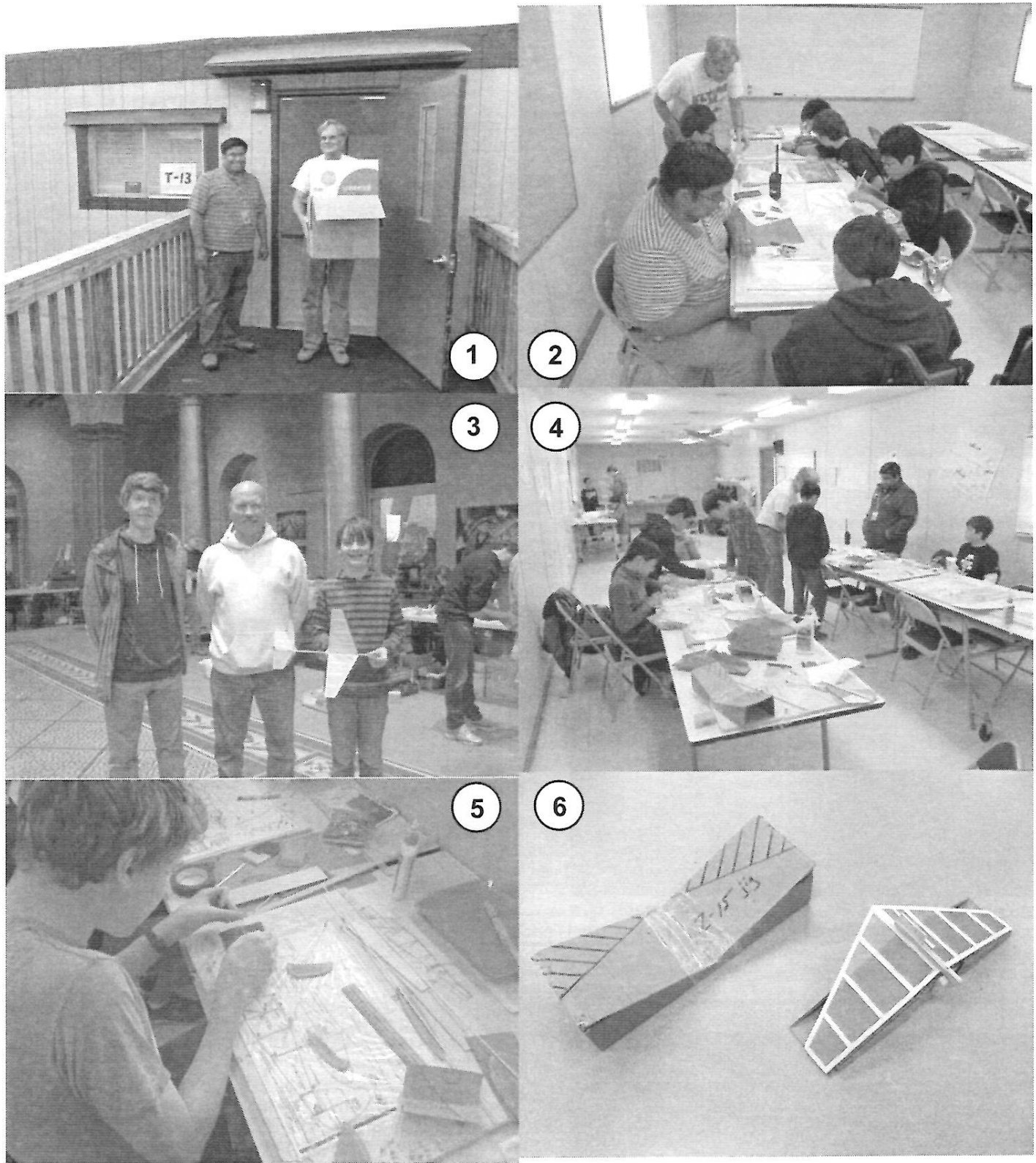

1. Eddie Alfaro & John Murphy moving onto the new club house.
2. Inside the club house.
3. Scott with Ben J. & Ben W. at the NBM.
4. Building session note Z-15 jigs at the end of the table.
5. Ben J. is now in high school but comes by to help the younger kids. Here he is working on a Bostonian.
6. Z-15 jig in use.

NMB R/C Report

Paul Stamison

We had a exciting time this first event of the year, the turn out was good and we had a special event this year. The Griffin father(Erik) and son(Arron)team were invited to come and put on a pattern plane show. It turned out to be a real show stopper and the audience were thrilled to watch the demonstration as seen in the video: <https://www.youtube.com/watch?v=C3SNRwye-rs> The rest of the time was spent in doing some flying around and seeing old friends and new pilots again. There was a lot of interested people asking about who/what this event was all about. We had a email list of those that wanted to know more of the events. We had some of our pilots give some of their flying time to many a young ambitious future pilots to actually let them fly some of their RC planes, I gave a few a opportunity to fly my Amber 2 and they were so excited to try it out. Some crashed and others were just "born naturals" is flying.

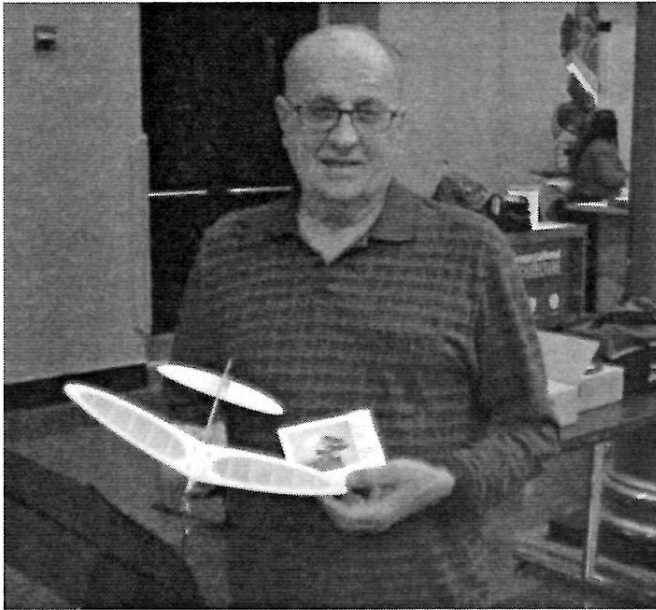

John Krouse with the wining balsa design. It's just a beautifully done craftsmanship and artful design

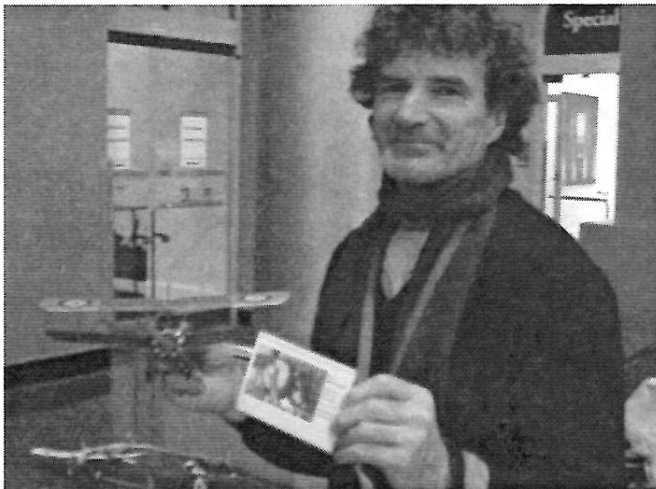

Here's best of foam construction a wonderful sample of a Sopwith Pup done by Pete Schumann using a Sopwith Triplane kit from Jin Choe (Jingmodels.com) and modifying it extensively to produce a wonderful Pup.

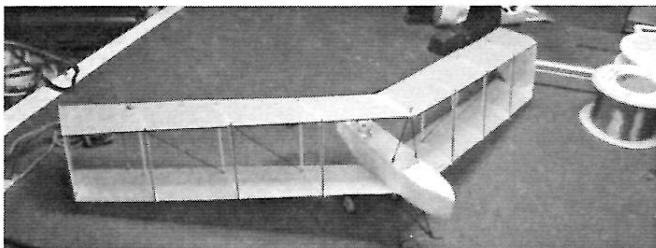

Jin's Burgess-Dunne-FlyingWing. A future kit we trust.



Last years winner, but this year in a different category -- most unique/creative design winner Ross Clements with his own design of a glider which was actually towed up by another micro plane and glided down after release it was a amazing job and flight, Plus with his very unique design winning was also based on his innovated idea of a trolley launch system for his UM Radian glider. It was one of the few designs (yet simple enough) that really worked well when he demonstrated it through many launchings of the UM Radian. A true young promising future engineer.

15g. Bostonian ML (4 entrants)	
1	Charlie Coeyman Peck Pup
2	Oliver Sand Banana
3	Ray Rakow B. Schick
Phantom Flash ML (13 entrants)	
1	Mike Moskow -
2	Oliver Sand -
3	Wally Farrell -
WW II No-Cal ML (13 entrants)	
1	John Appling Macchi C205V
2	Wally Farrell P-39
3	Dean Giacopassi Brewster Buffalo
Parlor Fly ML (8 entrants)	
1	Wally Farrell -
2	Steve Fujikawa -
3	Oliver Sand -
Dime Scale ML (4 entrants)	
1	John Houck Rearwin
2	Wally Farrell ONG
3	Steve Fujikawa Farman Stratoplane
ZAIC Z-15 ML (5 entrants)	
1	Ray Rakow
2	John Murphy
3	Paul Spreiregen
Limited Pennyplane (8 entrants)	
1	Brett Sanborn 6:37
2	Billy Batkins 4:39
3	Abram VanDover 4:25
	Bill Shepard 3:58
	Paul Spreiregen 3:17
	Mark Houck 1:58
	Thomas Schill 1:55
	Dean Giacopassi 1:20
FAC NoCal (7 entrants) - TTF	
1	Dave Mitchell 306 sec.
2	Sharon Appling 269 sec.
3	Wally Farrell

A-6 (5 entrants)	
1	Brett Sanborn 4:18
2	Charlie Coeyman 4:03
3	Abram VanDover 1:40
	Dean Giacopassi 1:33
	Mark Houck 1:08

National Building Museum January 18, 2015 Glen Simpers

We had 29 flyers for Freeflight, and 11 for RC. The rainy day outside meant that there was an extreme number of families visiting the museum with lots of visitor interest and questions.

Grand Champ was Wally Farrell. His win in Parlor Fly and high placing in a large number of events pushed him over the top. On his heels was the strong showings of the next generation by Erika Escalante and Oliver Sand, followed by the rest of us. It was fun to have a number of young fliers join in the fun. The presence of young fliers was very interesting to a number of visiting families. In addition to the normal fare, a rubber-powered TSA Competition model made good use of the high NBM ceiling to help prepare for High School Spring competitions.

We were concerned by the installation of architectural models around the flying space but their intrusion was not that bad. We had to use NBM staff to retrieve models but not that many were ensnared.

The most popular events were Phantom Flash and WW-II NoCal mass launch with 13 fliers each. There were four Brewster Buffaloes in WW-II NoCal from a popular kit with some having the same color scheme. John Appling won the event with the only Finish model.

The smaller number of RC fliers meant that some of the planned RC events were not run. We had an interesting demonstration of 3-D flying by Aaron Griffin. This created a lot of interest with the visitors and perhaps we can have a similar demonstration in March.

Special thanks go to the many who explained models to visitors. Thanks go out to those helping kids in the Delta Dart program. Paul Stamison ably ran the RC events.

FAC Peanut Scale (3 entrants)			SCORE
1	Wally Farrell	Piper Cub	49 sec 109
	Const. 29	Color 20	Work 11 Bonus 0
2	John Houck	Anderson	28 sec 101
	Const. 29	Color 19	Work 10 Bonus 15
3	Mike Escalante	Taube	42 sec 87
	Const. 15	Color 15	Work 10 Bonus 5

Peck- Polymers returns!

Chuck Imbergamo of Wind-it-up Enterprises (new owner of Peck-Polymers) announced he now has the inventory in Conn.

<http://www.peck-polymers.com/>

FAC-GHQ PEANUT SCALE

A traditional FAC event, where a unique scoring system promotes equal competition between highly detailed and less detailed models. The rising model lifts all wings....

- A. Open to any scale model of not more than 13 inches wingspan.
- B. All models must be covered with Japanese tissue or equivalent.
- C. All surfaces must be double covered, unless real ship was single covered.
- D. Planes with retractable gear may be built with the gear represented in the up position with no penalty.
- E. Proof of scale must be presented for scale points.
- F. NO maximum flight time.
- G. SCORING:

1. **Flight Score:** Total of three official flights.
NO MAX TIME!

2. **Scale Judging Points:** Total of the following:

- a) COLOR—Reasonable effort to use tissue and /or paint to simulate realistic coloring: up to 3 points
- b) MARKINGS— Civil registration, striping, insignias, serial numbers, squadron markings, etc. up to 3 points
- c) DETAILS—Struts, cowls, cylinders, pilots, rigging, armament, steps, windshields, exhausts, control surface outlines and other outstanding details:
STARK: minus 3 points
LAX: 0 points
GOOD: 3 points
GREAT: 6 points

3. **Scale Score:** Multiply your *Scale Judging Points* by the first two digits of the best GHQ Peanut flight score of the day—the *Event Multiplier*.

- a) *Example:* If the best three flight total is 279 seconds, *everyone's* scale judged point total is multiplied by "27."
- b) If only 2 digits comprise the top score (i.e. 97 seconds) then only the first digit will be used as the multiplier and everyone's scale judged point total will be multiplied by "9".

4. **TOTAL SCORE:** Flight Score + Scale Score.
Highest Total Score wins.

Page 19 Photos

All courtesy of Robert W. Madden except #4.

1. Peter Dudley's T28B No-Cal spirals up in this unique shot.
2. John Appling's Macchi C205V flirting with the columns.
3. Mass launch of Phantom Flashes.
4. A Phantom Flash cruises rather too close to the balcony. A Julie Farrell photo.
5. The final Phantom Flash launch is ROG, here we see Wally Farrell and Mike Moskow.
6. A Phantom Flash heading up nicely centered in the space.
7. Glen Simperts with Mike Moskow, the winner.

5. **Tiebreaker:** Single fly-off, timed. Highest time establishes the *Event Multiplier*. Multiply flight times by 3 to arrive at the *Flight Score*. Using the *Scale Judged Points* awarded earlier, proceed as in "G. Scoring" above to determine the Total Score for each tiebreaker contestant.

SCALE JUDGED POINTS	Color	
	Markings	
	Detail	
	TOTAL Scale Judged Points	
	Event Multiplier	X
	TOTAL SCALE SCORE	
	+ FLIGHT SCORE	+
	= TOTAL SCORE	

NBM rear cover PHOTOS

On the back cover in addition to Alan's diorama photo of his Monoprep, we have three of Robert W. Madden's superb photos. The overall shot of the atriums shows the spectacular flying space. This was early in the day before the crowd congregated. Next we see Steve Fujikawa's Parlor Fly cruising under the catwalks well above the columns. Of course these high flying models occasionally hang up on the columns. The next photo shows a pole being used to persuade a model off one the columns. Yes, the effort was successful. Usually we have to wait for an annual cleaning to achieve retrieval.

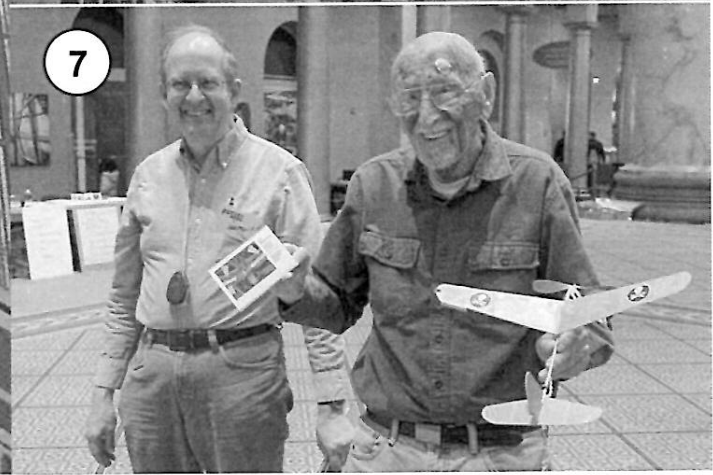
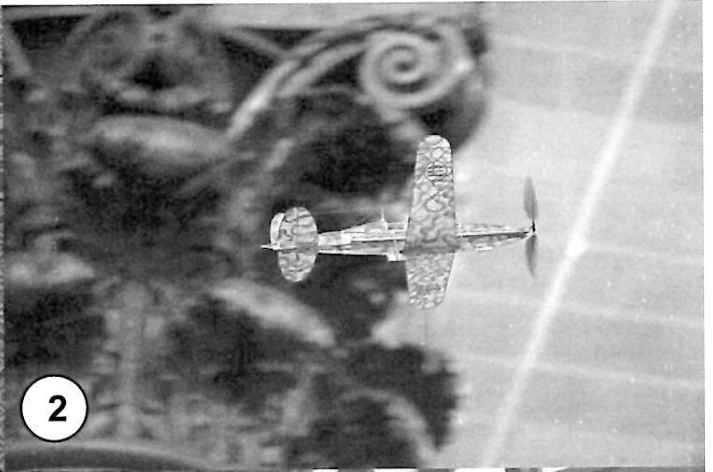
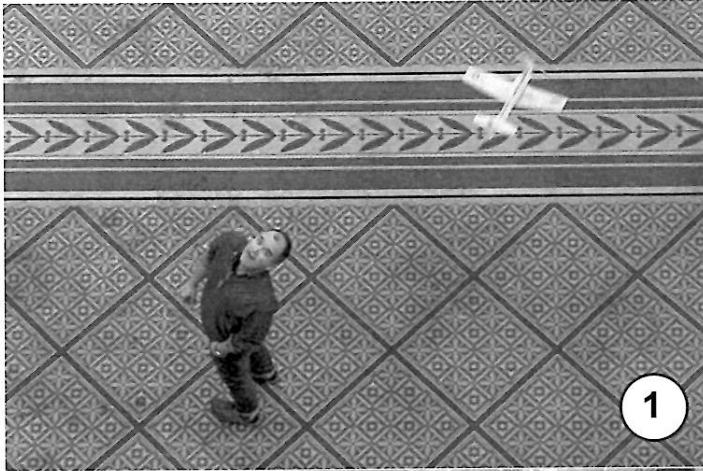

MaxFax 2015-1



CONTENTS:

PEANUT & DIMESCALE MONOPREPS
JAN 15 NBM RESULTS
FAC #75 FOO FIGHTERS REPORT
GHQ PEANUT RULES
LOUVERS KUDZU FLYER

D. C. MAXECUTERS
% STEW MEYERS
8304 WHITMAN DR.
BETHESDA, MD 20817

PRSR STD
US POSTAGE
PAID
PERMIT 6388
SUBURBAN MD

2*2***** ALL FOR ADC 210
201502
Mike Escalante
Or Current Resident
212 Division Ave
Hagerstown MD 21740-5040

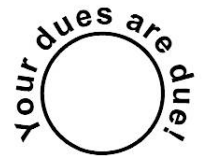
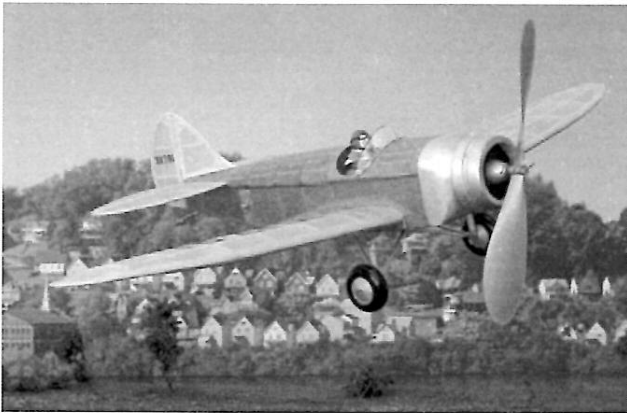

You can now renew on line!
Go to MaxFax on the website
www.dcmmaxecuter.org



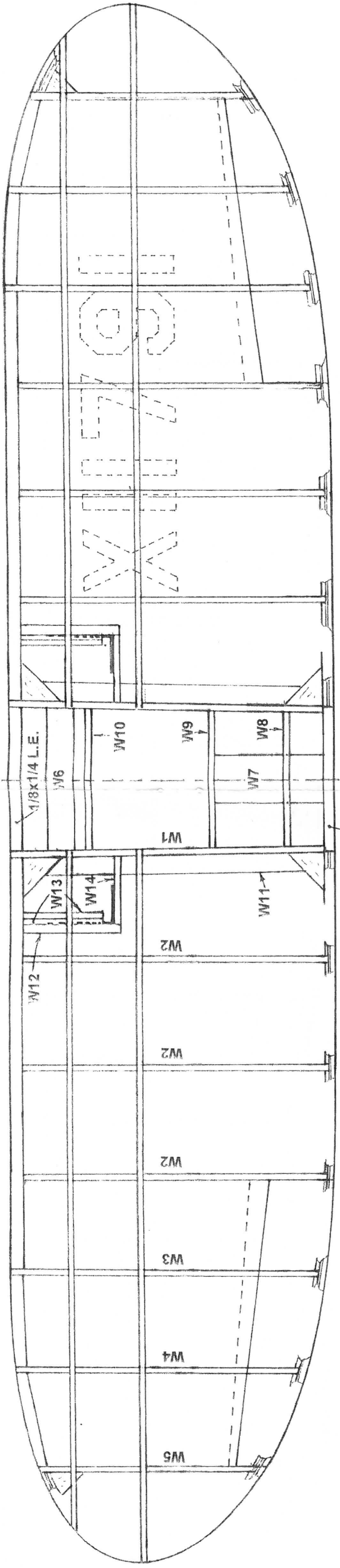

1/16x1/8 T.E.

REFERENCES

FLYING ACES, Dec., 1936, pg 36. Photo of Lambert Monosport, registration appears to be X 1179

MODEL BUILDER, Nov., 1993, pg 41. Model plan and text for 1935 Lambert Monoprep.

U.S. CIVIL AIRCRAFT, Juptner, Vol.7, ATC 674, Culver Dart. Text describing transition of Lambert aircraft to Culver Dart.

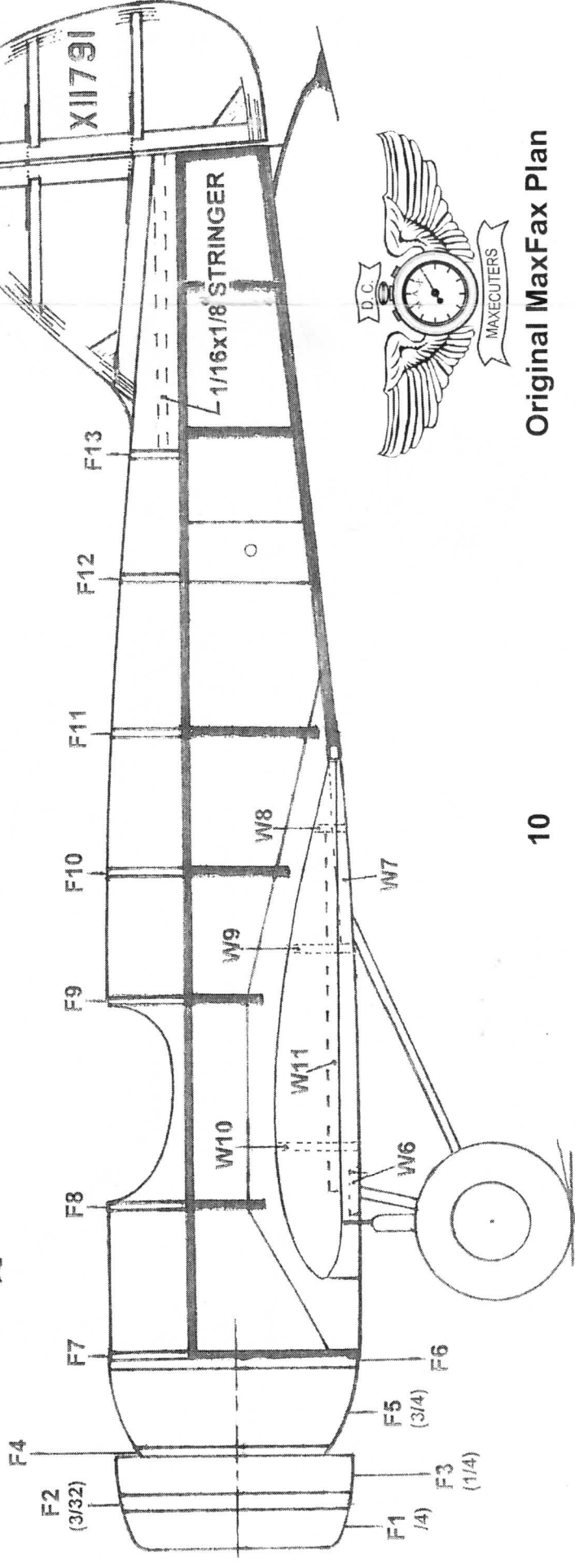
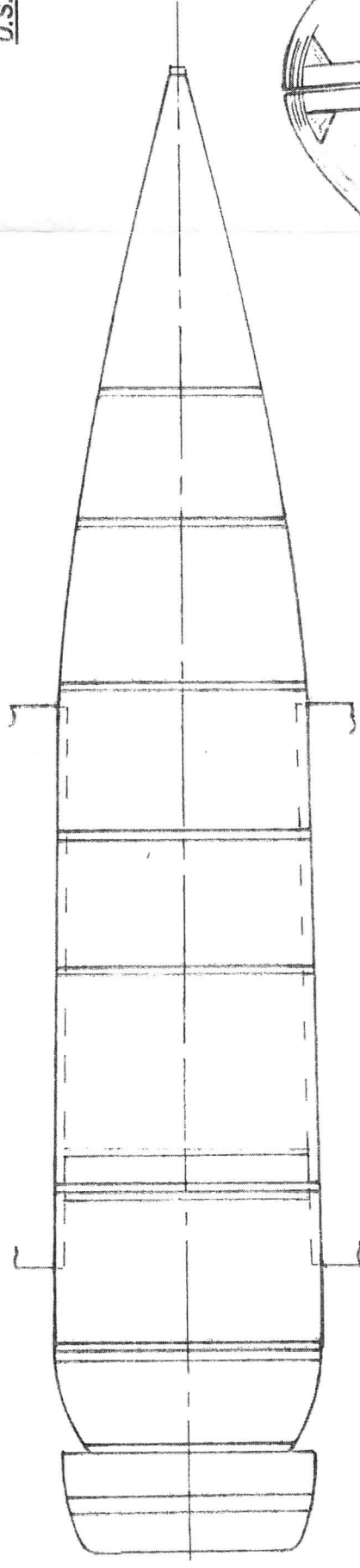

Original MaxFax Plan

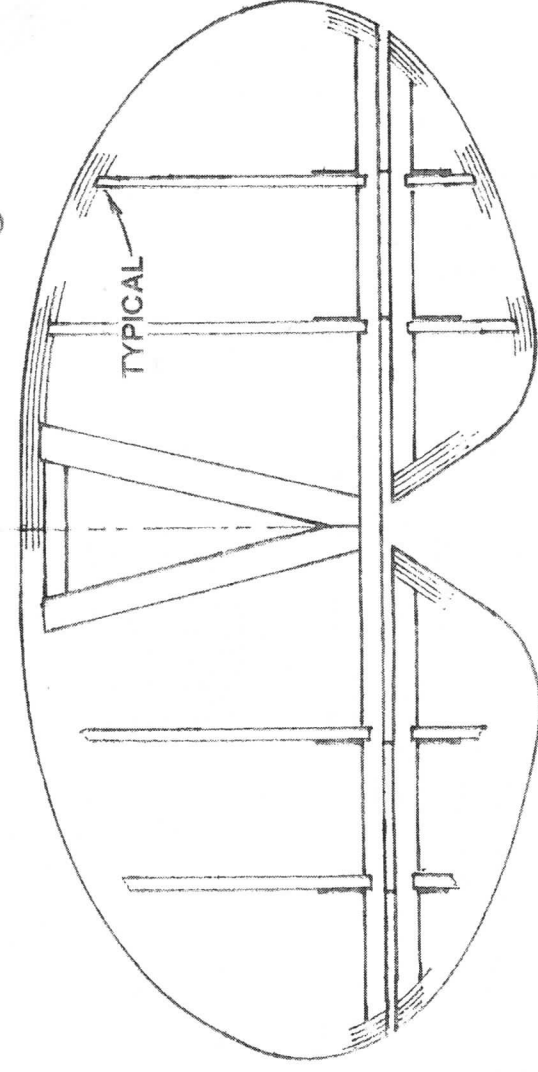
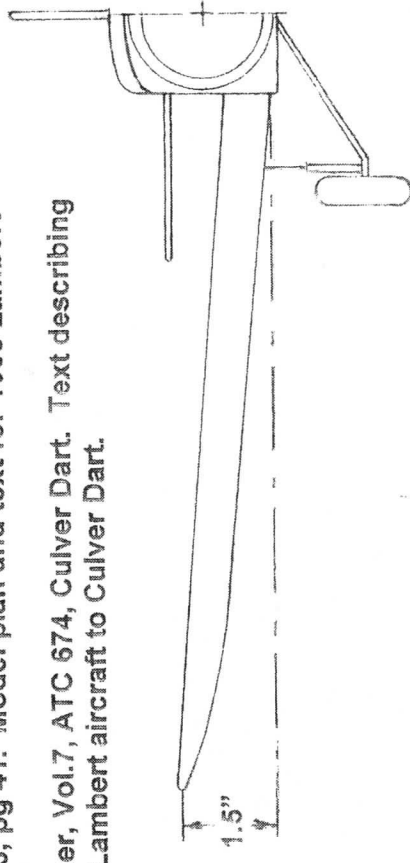

LAMBERT AIRCRAFT CORP.
MONOPREP TRAINER
 Engine: Lambert R-266, 90 hp
 Allan Schanzle December 2013

